



Fillflex product catalogue



**CHRISTIAN
BERNER**

Expect more

About Christian Berner



We create innovative technical solutions for a sustainable society

We ensure that algae cells are efficiently destroyed, that the damping material in helipads can cope with the strains to which it is subjected, as well as securing clean drinking water – among many other things. Whatever industry you work in, you can always expect more when you work with us.

Our own brand, Fillflex, manufactures flexible filling machines for liquids and viscous products in the food, pharmaceutical and hygiene industries, as well as for chemical products. Fillflex has developed complete systems for all types of filling operations.

Thanks to our technically highly trained teams, we are able, right from the start of our customer relationships, to ensure that our products and services are not only adapted for the purpose, but they also contribute to the lowest possible production costs.

Creating sustainable values for our customers' businesses

Our products and systems provide us with the opportunity to reduce our customers' environmental impact. And in addition to the environmental benefits, our technical solutions also create financial benefits for our customers – that's what we call sustainability.



Table of Contents

About Christian Berner AB	2
Table of Contents.....	3
Fillflex control systems.....	4-5
Fillflex Compact.....	6-7
Fillflex Split	8-9
Fillflex Duplex	10-11
Fillflex Sequence.....	12-13
Fillflex Pumps	14-15
Fillflex Feed System.....	16-18
Production lines	19
Options	20-22
Accessories.....	23-35
Spare parts	36
Installation & Service.....	37
Contact.....	39

Our customised solutions

Fillflex has been developing customised solutions for volumetric filling of liquid products for more than 25 years. The name "Fillflex" stands for flexible filling and can basically help to fill anything that can be pumped, using the various pumps that are currently on the market.

The filling process is mainly controlled using a return feedback signal from a rotary encoder embedded in the pump motor" and the volume of the pump (displacement) in combination with the number of rotations thereby provides an accurate filling volume.

Fillflex can handle almost any type of liquid, even extremely viscous or foaming liquids. For example, it is used for filling jam, almond paste, vanilla cream, sauce, liver pâté, dressings, brine, yogurt, mayonnaise, honey, dishwashing detergent, shampoo, degreaser, hand cream, paint, acid and oil.



“We build customised machines with standard components”

Control systems

Fillflex control systems are user-friendly and adapted to be taken into operation easily, and to deliver continuous filling of a selected product in the selected package. Our solutions can be customised to fill smaller batches with semi-automatic as well as fully automatic filling, in production lines where the filling machine is integrated in a solution with a conveyor belt, infeed table, encapsulation and outfeed.

The control systems have been developed over the years, and we can now offer four different ways to control a filling operation.

Fillflex F5500

Our well proven unit and the Fillflex control that handles most semi-automatic and automatic filling operations. The control system and operator panel are an integrated unit and are mounted in the door of the control cabinet. The operator panel has a number of functions where filling operations can be run automatically or manually to prime the system, or for adjusting filling volumes. The operator can easily adjust volume & filling speed with the press of a button on the panel, and can save the new settings equally easily. Eight different filling recipes can be saved, the speed of the pump can be adjusted from 0-100%, and filling can start and finish at a lower speed in order to reduce the risk of foaming and overfilling. The pump can be reversed for a short period at the end of the filling process to prevent product dripping.

The F5500 is almost indestructible, and many units have been in operation for more than 20 years. For the Fillflex F5500, we offer an exchange system for the operator panels, which economically and sustainably allows the customer to quickly replace a malfunctioning panel with an inspected, working panel with a warranty.

Control of a filling valve with feedback signal is included, and communication to an external line with the ready for filling signal and an external start signal is available as standard. A pneumatic foot pedal or an electric starter handle can be connected for external start of filling.



Fillflex F6600

Our latest development in control systems for volumetric filling. In addition to all the features on the F5500, the control system offers the potential to store 30 different filling recipes. In addition, software can be added to handle two of our much appreciated options, Duplex filling and Sequence filling (see description under each section for more information). The F6600 has an operator panel that is mounted in the control cabinet's door, or, optionally, an external operator panel with a cable connection.

Control of 1-4 filling valves with feedback signal can be included, and communication to an external line with the ready for filling signal and an external start signal is available as standard. A pneumatic foot pedal or an electric starter handle can be connected for external start-up of filling.



Fillflex F2100

This is our control for filling packages using weight-based dosing. The machine includes a load cell and a control system for programming weight dosing. The filling operation can be run in relation to net or gross weight, which enables dosing up to the preselected weight or filling up to the preselected total weight (if you want to add more product to an already half-full package).

The control system can handle pre-fill and top-up, as well as bottom filling for foaming products.

The panel has a touch panel and can handle programming, recipes and logging (through external software).



Fillflex F7700

Our F7700 control system includes a PLC control systems with a touch panel, where Fillflex has customised the software. The control system is most commonly used for gravity filling (through one or more valves) and filling using flow meters. The F7700 can be adapted and customised for a number of customer applications and, in addition to dosing and filling, can also control other line equipment such as conveyor belts, infeed and outfeed tables, encapsulation, etc.



Fillflex™ Compact

Fillflex Compact is a flexible, easy-to-handle and user-friendly filling machine for pumpable liquid products.



F6600 with built-in operator panel



F6600 with external operator panel



F5500C with filling hopper

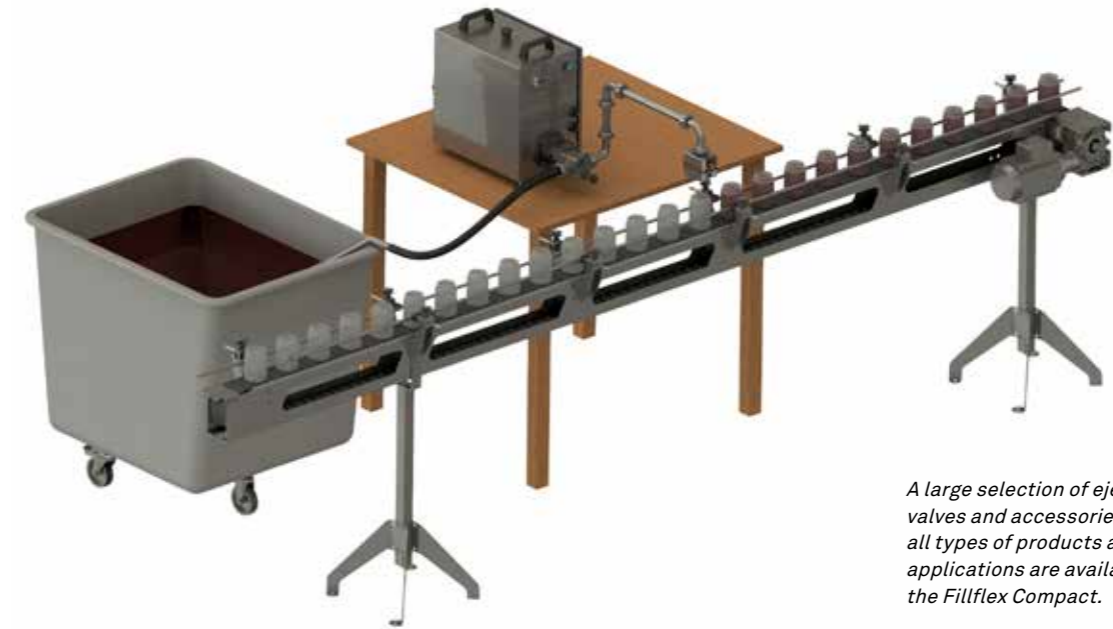

A large selection of ejectors, valves and accessories for all types of products and applications are available for the Fillflex Compact.

The machine contains of a stainless steel cabinet with integrated control system, motor and pump. The unit is small, weighing approximately 25 kg, and has handles for full mobility. It can be placed on a workbench or on a trolley, which is available as an

accessory.

Fillflex Compact is available with 3 different control systems, depending on the application and the choice of working method. It is very easy to clean and all the pumps can be dismantled without tools. The entire machine is made of stainless steel and can easily be washed off. Valve control is included as standard in all machines. A foot pedal or a starter handle is available as an accessory for external starting.

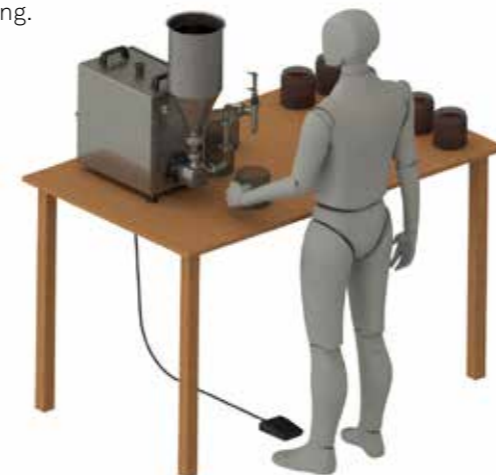
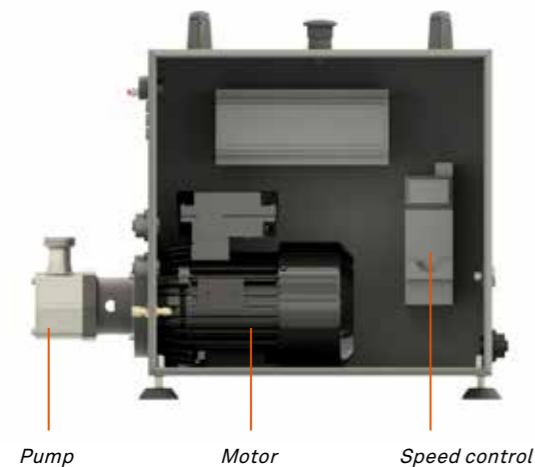

CONTROL SYSTEMS	F5500C	F6600C	F2100C-VR30
Max. power motor control:	0.55 kW	0.55 kW	0.55 kW
Valve guides:	1	1-4	1
Number of recipes	8	30	8
Dosing principle	Volume	Volume	0-30,000 g
Ready signal	Yes	Yes	Yes
External start	Yes	Yes	Yes
External op. panel		Yes - F6600op	

PUMPS	PD-M200C	PD-M210C	PD-M220C	PD-28220C	PD-28320C
TYPE	Gear	Gear	Gear	Impeller	Impeller
Max. capacity	8 l/min	13 l/min	25 l/min	35 l/min	60 l/min
Displacement	0.006 litres/rev	0.010 litres/rev	0.018 litres/rev	0.023 litres/rev	0.053 litres/rev
Rec. filling volume	10-200 ml	10-500 ml	20-1,500 ml	30-2,000 ml	60-4,000 ml
Stainless steel 316L	Yes	Yes	Yes	Yes	Yes
O-ring*	Viton	Viton	Viton	Nitrile	Nitrile
Impeller	N/A	N/A	N/A	Neoprene/EPDM**	Neoprene/EPDM**
Max temp (°C)	<60	<60	<60	<60/<100	<60/<100
Solid particles?	No	No	No	Yes	Yes
Suitable for food	Yes	Yes	Yes	Yes	Yes

Connections: Electricity: 230 VAC plug, Air: max 6 bar

* also available in EPDM and Nitrile

** Impeller in Neoprene as standard. If EPDM is selected, add suffix EPDM. Example: "PD-28220C-EPDM"

Fillflex™ Split

Fillflex Split can be combined with a large selection of dosing pumps from our range, and can handle just about all types of liquids, high and low capacities as well as highly viscous or foaming products. As the pump unit is not integrated in the control cabinet, there are no restrictions regarding the size or weight of the pump.

- Adaptable for different pumps
- Large dosing range
- Flexible positioning of control cabinet & pump



Split means that the pump unit is separated from the control cabinet, either because the pump is simply too large to be integrated or because the process requires a different location.

Split

Fillflex Split is a flexible filling machine that can be mounted on a trolley with wheels (Split Trolley) or be mounted on a wall (Split Wall), depending on the application.

The control system, frequency converter and valve control are built into the stainless steel control cabinet.

To control the F6600, an external control panel that can replace the panel in the door is available as an option.

A pump with a motor unit can be placed at the bottom of the trolley, or at the level required by the process. If a trolley is not selected, a pump with a motor unit on the bottom plate can be placed directly on the floor.

Fillflex Split is available for all four of our control systems: F5500, F6600, F7700 and weigh filler F2100.

There are three different trolleys to choose from under accessories. There is a wall mount for the control cabinet for Split Wall.

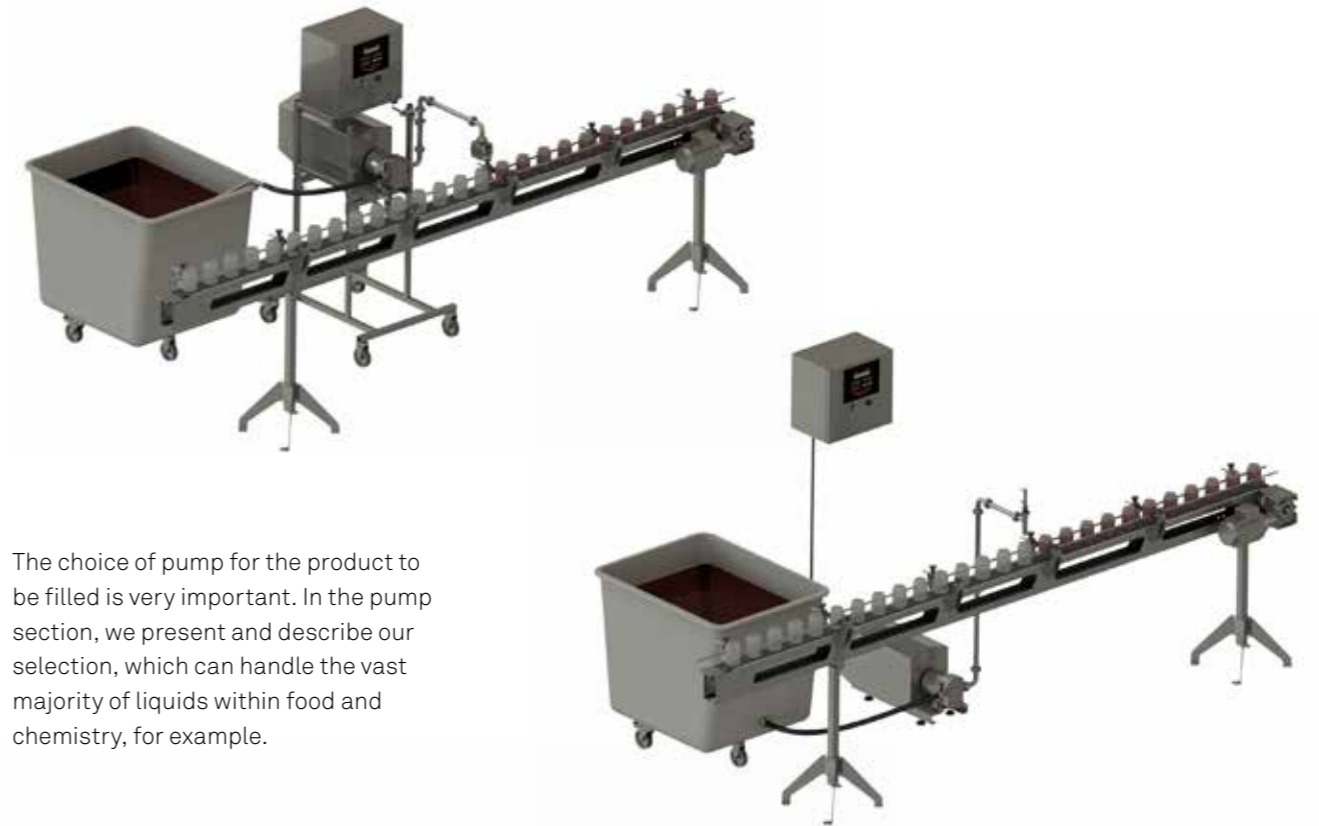

The choice of pump for the product to be filled is very important. In the pump section, we present and describe our selection, which can handle the vast majority of liquids within food and chemistry, for example.



“At Fillflex, we have extensive experience of pumps that are suitable for dosing, and we can also offer pumps that are not included in our regular range. Always feel free to ask us if you are unsure about the choice of pump.”

Configurations	F5500S*	F6600S*	F7700S*	F2100S*
Max. power motor control	* 0.75 kW 1.5 kW	* 0.75 kW 1.5 kW	* 0.75 kW 1.5 kW	* 0.75 kW 1.5 kW
Valve guides	1	1-4	1-16	1
Number of recipes	8	30	250	8
Dosing principle	Volumetric	Volumetric	Customised	Weight

Connections: Electricity: 230 VAC plug, Air: max 6 bar

Fillflex™ Duplex

The Duplex feature provides a Fillflex with virtually double the capacity. This feature is available as an option for our F6600 control system, where it can be selected in both the Compact and the Split versions.

- Continuous alternating filling
- Maximum pump utilisation
- Increased production capacity
- Semi-automatic & Fully automatic operation



Configuration example:
Semi-automatic machine, F6600
Split – Duplex mounted on trolley with integrated table.

Duplex

Duplex means that the filling machine has two separately controlled product outlets, which allow continuous filling without breaks.

This enables rapid manual handling and automatic alternating filling of two packages. The Duplex function requires a symmetrical outlet, splitted into two pipes with filling valves.

For semi-automatic operation, filling is started with the help of a package fixture, where each compartment is equipped with a sensor that initiates filling.

Filling starts when a package is placed in either compartment. After this, another package is placed in the other compartment. When the first package

has been filled, the filler automatically switches over to the other package and starts filling. The filling process continues alternately or in the compartment where the package has been removed and replaced with a new one and the sensor has been actuated.

Duplex can also be used in case of fully automatic operation, as the function enables automatic alternating filling of two packages side by side on a conveyor belt with parallel tracks.

Using a queue management function, a gate automatically releases one package at a time to the filling position that becomes vacant. The track that has fed a package to the filling location sends a signal to the machine, which starts filling the relevant package.

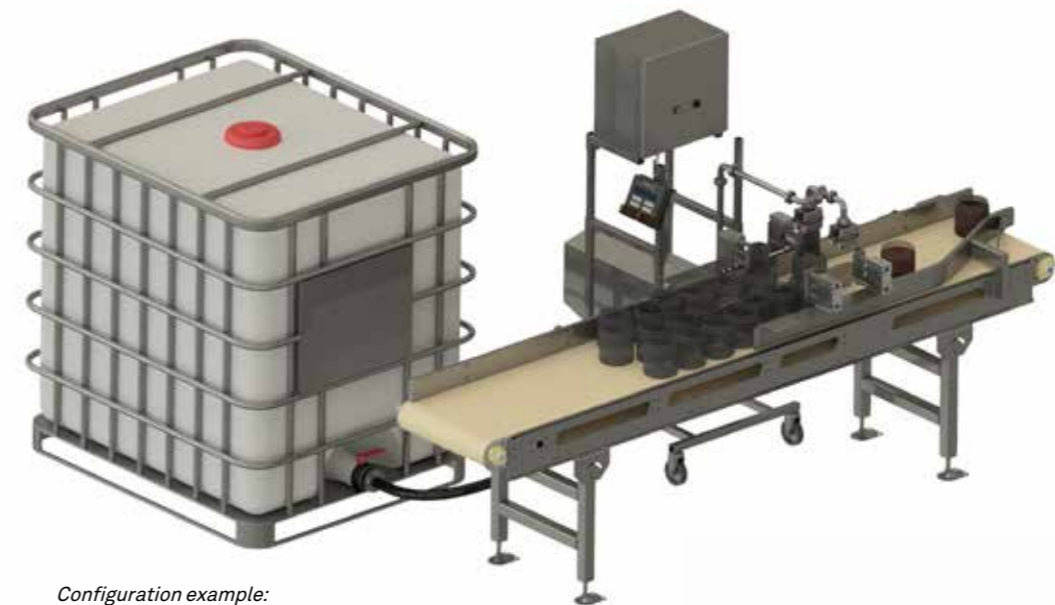

Configuration example:
The above machine equipped with a conveyor belt for fully automatic operation.



Configuration example:
F6600CD with Duplex Kit, Compact

Configurations	F6600CD	F6600SD-0,75	F6600SD-1,5
Max. power motor control	0.55 kW	0.75 kW	1.5 kW
Version	Compact	Split	Split
Number of recipes	30	30	30
Dosage	Volumetric	Volumetric	Volumetric

Connections: Electricity: 230 VAC plug, Air: max 6 bar

Duplex Kit Compact includes a symmetrical product outlet and stand components for the package fixture, including start signal sensors. The stand is mounted under the control cabinet. In addition to the above parts, Duplex Kit Split includes an extended product outlet and package fixture that is mounted directly on the Trolley.

Order number:

FF_A0-DC-01	Duplex Kit, Compact	excl. valves and stand
FF_A0-DST-01	Duplex Kit, Split Trolley	excl. valves and stand

Fillflex™ Sequence

- Can fill 2 to 4 packages in a row or in pairs that are fed forwards
- Easy to adapt to lines such as packaging machines
- Flexible filling speed & volume adjustment
- Wide selection of valves and outlet diameters



Configuration example: Fully automatic machine, F6600S4 with grouped filling outlet.

Sequence

The Sequence function allows a single machine to fill two, three, or four packages of the same volume in sequence.

The Sequence function makes full use of the filling machine by conducting up to four filling operations in sequence. This feature is available as an option for the F6600 and effectively uses the waiting time in between strokes on a packaging machine, as well as the sealing time on automatic packaging machines filling.

Depending on the number of packages side by side, the control system is equipped with 2, 3 or 4 valve controls.

In the case of more than 4 packages, two or more Fillflex sequence machines can be placed next to each other in an automated production line.

Configuration example: Fully automatic machine, F6600SS3 with three packages side by side.



Configuration example: Fully automatic machine, F6600SS4 with four packages side by side.



Configurations	F6600CS2	F6600CS3	F6600CS4	F6600SS2*	F6600SS3*	F6600SS4*
Max. power motor control	0.55 kW	0.55 kW	0.55 kW	* 0.75 kW 1.5 kW	* 0.75 kW 1.5 kW	* 0.75 kW 1.5 kW
Valve guides	2	3	4	2	3	4
Number of recipes	30	30	30	30	30	30
Dosage	Volumetric	Volumetric	Volumetric	Volumetric	Volumetric	Volumetric
Version	Compact	Compact	Compact	Split	Split	Split
Number of sequences	II	III	IV	II	III	IV

Connections: Electricity: 230 VAC plug, Air: max 6 bar

Order number:

FF_AO-SP25-2	Sequence pipe, 2	dimensions must be specified
FF_AO-SP25-3	Sequence pipe, 3	dimensions must be specified
FF_AO-SP25-4	Sequence pipe, 4	dimensions must be specified

Fillflex™ Pumps

Our extensive experience of pumps for dosing and filling applications has provided us a wide product range, which is suitable in the vast majority of cases. We help you to select the specific pump type to match your needs.

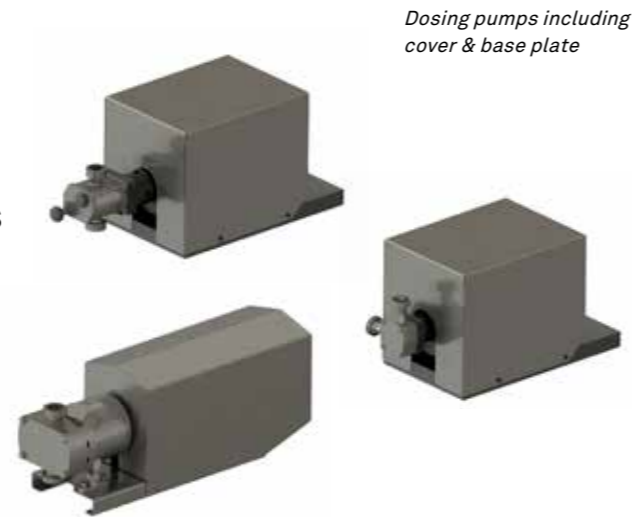

Different types of products in the food and chemical industries require different pump principles, materials and seals in order to function optimally. It is also important for the pump to be tailored to the liquid that is to be filled, with regard to viscosity, particles, pieces and corrosive products. Gentleness in relation to the product is always important to avoid foaming and product wear. A low speed through the pump is often preferable.

Most of our pumps are suitable for food and are made of stainless steel. We also have pumps with a flushed seal for e.g. sugar solutions and water-based paint, etc. The pump models that we currently offer in our standard range are gear pumps, impeller pumps and lobe rotor pumps.

Gear pumps

Suitable for a variety of thin or viscous liquids without particles. For example, oil and oil-based products, solvent and water-based paints, detergents, skin creams, foods, etc. All parts that come into contact with products are made of food grade material.

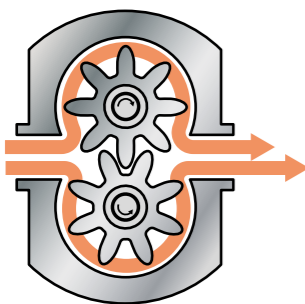

Impeller pumps

Suitable for a variety of thin or viscous liquids that may also contain particles. Excellent self-priming ability.

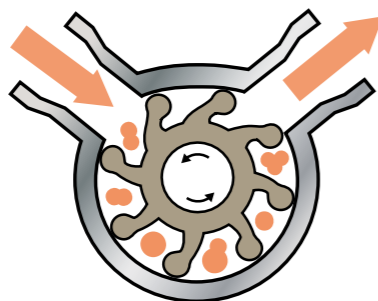

Lobe rotor pumps

Gentle and extremely well suited to viscous products. Also suitable for products that containing pieces, such as mayonnaise-based salads, potato salad, fruit yoghurt, etc. Available for small capacities as well as large capacities. Low pump speeds ensure gentle handling of sensitive products.



GEAR PUMPS	PD-M200	PD-M210	PD-M220	PD-R40	PD-R50
Max. capacity	8 l/min	13 l/min	25 l/min	50 l/min	100 l/min
Displacement	0.006 litres/rev	0.010 litres/rev	0.018 litres/rev	0.08 litres/rev	0.22 litres/rev
Rec. filling volume*	10–200 ml	10–500 ml	20–1,500 ml	100–3,000 ml	300–9,500 ml
Motor output	0.55 kW	0.55 kW	0.55 kW	0.75 kW	1.5 kW
O-ring	Viton	Viton	Viton	PTFE	PTFE
Gear	Stainless steel 316L	Stainless steel 316L	Stainless steel 316L	Stainless steel 316L / Cast iron	Stainless steel 316L / Cast iron
Max temp (°C)	<60	<60	<60	<130	<130
Solid particles?	No	No	No	No	No
Suitable for food?	Yes	Yes	Yes	No	No
Flushed seal				Optional	Optional

IMPELLER PUMPS	PD-28220	PD-28320
Max. capacity	35 l/min	60 l/min
Displacement	0.023 litres/rev	0.053 litres/rev
Rec. filling volume*	30–2,000 ml	60–4,000 ml
Motor output	0.55 kW	0.55 kW
O-ring	Nitrile	Nitrile
Gear	Neoprene/EPDM**	Neoprene/EPDM**
Max temp (°C)	<60, <100	<60 / <100
Solid particles	Yes	Yes
Suitable for food?	Yes	Yes
Flushed seal	Optional	Optional

** Impeller in Neoprene as standard. If EPDM is selected, add suffix EPDM. Example: "PD-28220-EPDM"

LOBE ROTOR PUMPS	PD-OP12	PD-OP13	PD-OP22	PD-OP23	PD-OP32	PD-OP33
Capacity	60 l/min	100 l/min	170 l/min	210 l/min	320 l/min	320 l/min
Displacement	0.06 litres/rev	0.10 litres/rev	0.17 litres/rev	0.21 litres/rev	0.32 litres/rev	0.40 litres/rev
Rec. filling volume*	100–3,000 ml	150–5,000 ml	200–3,500 ml	250–4,500 ml	350–4,000 ml	400–9,000 ml
Motor output	0.75 kW	0.75 kW	1.5 kW	1.5 kW	1.5 kW	1.5 kW
O-ring	Viton	Viton	Viton	Viton	Viton	Viton
Rotor / Impeller	Stainless steel 316L	Stainless steel 316L	Stainless steel 316L	Stainless steel 316L	Stainless steel 316L	Stainless steel 316L
Max temp (°C)	130	130	130	130	130	130
Solid particles	<6 mm	<6 mm	<8 mm	<8 mm	<10 mm	<10 mm
Suitable for food?	Yes	Yes	Yes	Yes	Yes	Yes
Flushed seal	Optional	Optional	Optional	Optional	Optional	Optional

*Rec. filling volume is based on filling a reasonable number of packages per minute at 50% pump speed. Larger volumes can be achieved with a longer filling time.

Fillflex™ Feed System

- Minimises problems associated with feeding product to the dosing pump
- Maintains a constant level in the product hopper for the dosing pump, which contributes to higher filling accuracy
- Reduces start-up problems associated with air in product inlets to the filling machine



When filling viscous products, the filling machine's pump is sometimes unable to draw the product from the storage tank or mixing tank. In this case, it is a good idea to use a product hopper as a buffer tank and a feed pump that maintains a constant level in the hopper, with the aid of a sensor. This solution also provides significant benefits when it comes to precise dosing, as the product level is continuously held to keep an even inlet pressure to the filling machine's pump.

The control cabinet for the feed pump contains a frequency control and is a separate unit as standard, but can also be integrated in a larger controller cabinet that also houses the control for the filling machine.

In most cases, the level is controlled by an ultrasonic sensor, which is mounted in the product hopper's cover. Some liquids may require alternative sensors, however, which can also be offered in such cases.

All the pumps in our range can be used as feed pumps, although in that case they are not equipped with rotary encoders for dosing.

As an option, there is a suitable trolley that turns the feed pump into a complete mobile device. Suitable suction and product line feed kits can be found in the Accessories section.

GEAR PUMPS	PF-M200	PF-M210	PF-M220	PF-R40	PF-R50
Max. capacity	8 l/min	13 l/min	25 l/min	50 l/min	100 l/min
Appropriate feeding capacity	4 l/min	7 l/min	13 l/min	25 l/min	100 l/min
Displacement	0.006 litres/rev	0.010 litres/rev	0.018 litres/rev	0.08 litres/rev	0.22 litres/rev
Motor output	0.55 kW	0.55 kW	0.55 kW	0.75 kW	1.5 kW
O-ring	Viton	Viton	Viton	PTFE	PTFE
Gear	Stainless steel 316L	Stainless steel 316L	Stainless steel 316L	Stainless steel 316L /Cast iron	Stainless steel 316L /Cast iron
Max temp (°C)	<60	<60	<60	<130	<130
Solid particles	No	No	No	No	No
Suitable for food	Yes	Yes	Yes	Yes	Yes
Flushed seal				Optional	Optional

IMPELLER PUMPS	PF-28220	PF-28320	PF-28420
Max. capacity	35 l/min	60 l/min	175 l/min
Appropriate feeding capacity	18 l/min	30 l/min	90 l/min
Displacement	0.023 litres/rev	0.053 litres/rev	0.125 litres/rev
Motor output	0.55 kW	0.55 kW	1.1 kW
O-ring	Nitrile	Nitrile	Nitrile/EPDM
Gear	Neoprene/EPDM*	Neoprene/EPDM*	Neoprene/EPDM*
Max temp (°C)	<60, <100	<60 / <100	<60 / <100
Solid particles	Yes	Yes	Yes
Suitable for food	Yes	Yes	Yes
Flushed seal	Optional	Optional	Optional

* Impeller in Neoprene as standard. When selecting EPDM, suffix -002, e.g.: "PD-28220-002C"

LOBE ROTOR PUMPS	PF-OP12	PF-OP13	PF-OP22	PF-OP23	PF-OP32	PF-OP33
Capacity	60 l/min	100 l/min	170 l/min	210 l/min	320 l/min	320 l/min
Appropriate feeding capacity	30 l/min	50 l/min	85 l/min	105 l/min	160 l/min	160 l/min
Displacement	0.06 litres/rev	0.10 litres/rev	0.17 litres/rev	0.21 litres/rev	0.32 litres/rev	0.40 litres/rev
Motor output	0.75 kW	0.75 kW	1.5 kW	1.5 kW	1.5 kW	1.5 kW
O-ring	Viton	Viton	Viton	Viton	Viton	Viton
Rotor / Impeller	Stainless steel 316L	Stainless steel 316L	Stainless steel 316L	Stainless steel 316L	Stainless steel 316L	Stainless steel 316L
Max temp (°C)	130	130	130	130	130	130
Solid particles	<6 mm	<6 mm	<8 mm	<8 mm	<10 mm	<10 mm
Suitable for food	Yes	Yes	Yes	Yes	Yes	Yes
Flushed seal	Optional	Optional	Optional	Optional	Optional	Optional

Fillflex™ Feed System

Control cabinet complete with automatic product level control and manual/automatic start.

Available in four versions, depending on motor output and if mounted in a separate control cabinet or integrated.

Order number:

FF_FSC-0,75-00	Control for feeding system, integrated.
FF_FSC-0,75-01	Control for feeding system, separate control cabinet FF_
FSC-1,5-00	Control for feeding system, integrated
FF_FSC-1,5-01	Control for feeding system, separate control cabinet

Product hoppers with one or two side inlet connections for use in combination with feed systems. Allows continuous topping up and, in some cases, also an additional outlet for recirculation.

Order number:

FF_AI-H10-25	Hopper, 10l, with SMS25
FF_AI-H10-25-25	Hopper, 10l, with SMS25 1x SMS25 inlet connection
FF_AI-H10-25-2x25	Hopper, 10l, with SMS25 2x SMS25 inlet connection
FF_AI-H10-38	Hopper, 10l, with SMS38
FF_AI-H10-38-38	Hopper, 10l, with SMS38 1x SMS38 inlet connection
FF_AI-H10-38-2x38	Hopper, 10l, with SMS38 2x SMS38 inlet connection
FF_AI-HL10	Lid for 10l hopper
FF_AI-HL10-M30	Lid for 10l hopper with M30 connection



Trolleys for feed systems

Feed systems with control cabinet and a pump are usually mounted on a Trolley Small or together with the filling machine on a Trolley Classic Feed. It is also possible to mount the parts as a fixed installation in connection with the product tank.

Order number:

FF_AS-TS-01	Trolley Small	(LxWxH) 500x470x1140
FF_ACF-TS-01	Trolley Classic Feed	(LxWxH) 660x600x1140

Fillflex™ Production lines

- Fully automated line
- Maximum production capacity with minimum staffing requirement
- Quality-assured production with automated processes

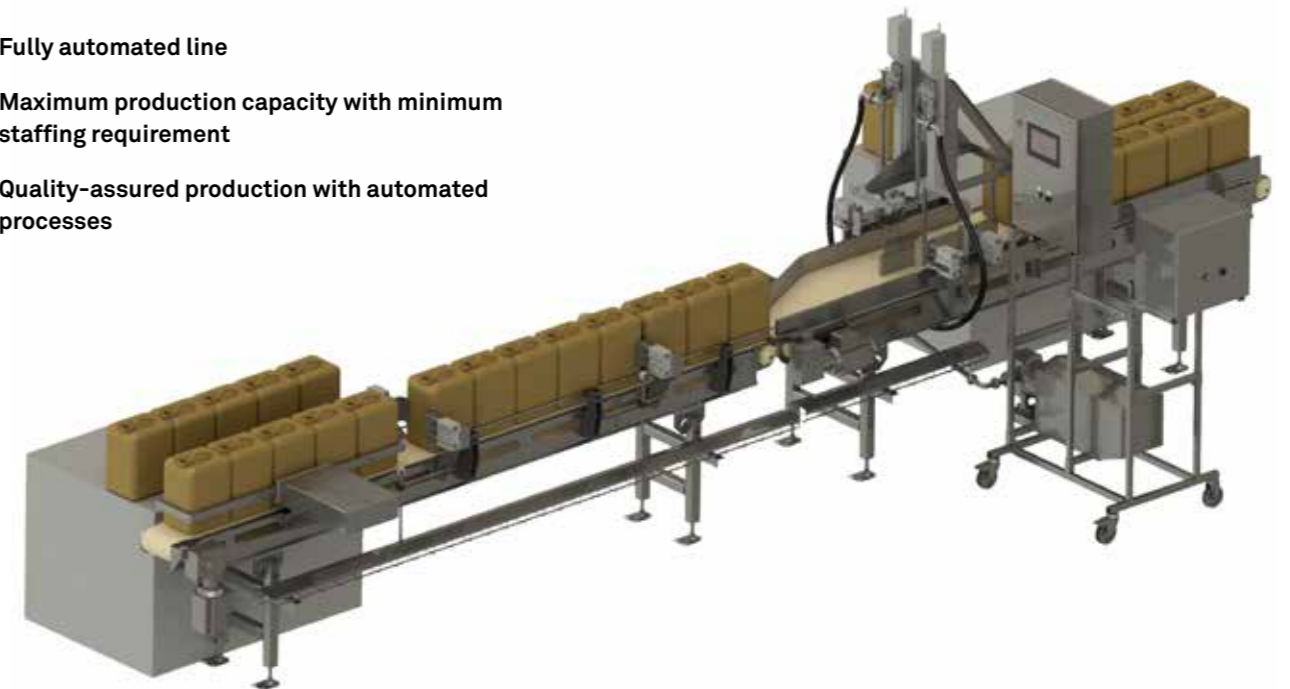

Fillflex can offer complete production lines for filling of all kind of liquid products. For more than 20 years, we have also helped our customers with the automation of filling processes, including accessories such as conveyor belts, infeed and outfeed tables, encapsulation machines, etc.

Our long experience has given us a successful network of partners, enabling us to offer customised solutions to improve the filling process and also fully automate a line.

Accessories such as these for a Fillflex filling machine are always customised and need to be managed in project form, which includes both project planning and 3-D CAD drawing.

Although ready-made solutions are available for components included in a filling station or a complete

line, there is always a need for customisation, layout drawings and function-testing.

In addition to a Fillflex filling machine, filling lines usually consist of:

- Infeed tables with or without feed automation
- Main conveyor with filling and encapsulation station
- Labelling and date marking
- Outfeed or rotary tables

The project and delivery time for this type of project, including manufacturing, is usually 2 to 3 months. We therefore usually offer budget prices on complete lines to make the customer's decision-making process and planning easier.

Questions regarding complete production lines are always welcome and we are happy to contribute with our long experience.

Fillflex™ Options

Fillflex™ BFE, Bottom filling, Electric

- Reduces foaming during filling
- Enables faster filling
- Reduces spillage
- Can be adapted to a large number of packages

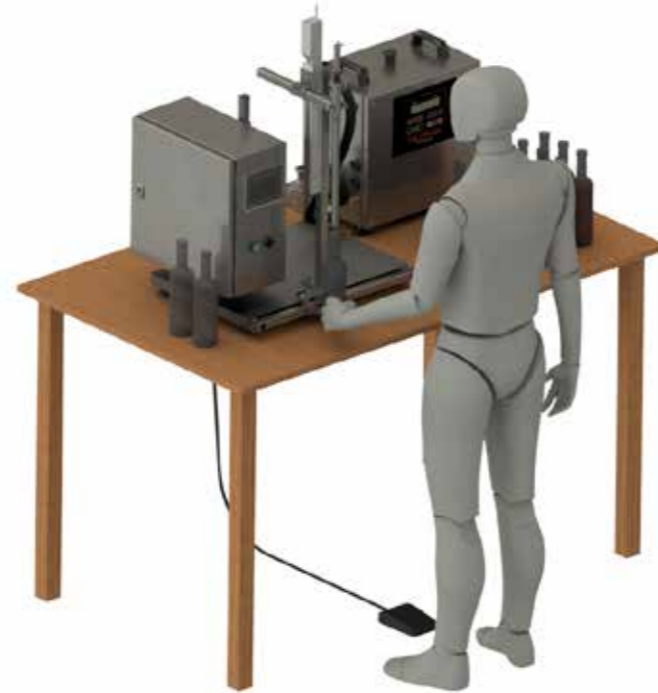

For foaming products, BFE (bottom filling) is recommended. This is a separate electrical unit, equipped with a stepper motor, controlling a bottom filling lance for immersion into the package and filling below the liquid level. Bottom filling minimises foaming and optimises both filling time and accuracy.

Bottom filling is available as an option for both Compact and Split, and is offered as a standalone unit for table mounting, for mounting on a trolley or mounting on a conveyor belt.

Max. standard stroke is 500 mm.

BFE is connected to and controlled by the Fillflex machine, but has a separate control panel with settings

for lance motion speeds, delay times, start and end positions. Filling can be carried out at a lower speed during the start and finish. The lance can also be adjusted to follow the liquid level upwards.

The control system for BFE can be supplied in a separate control cabinet with a control panel for the functions, or be integrated in a Fillflex Split cabinet, type Large.

The function can be retrofitted and can complement a previously delivered Fillflex filling machine.

Fillflex™ QP, Queue & Positioning

- Full automation of filling process by conveyor belt
- Optimised filling speed through minimal stop times for packages during filling
- Does not require signal exchange with conveyor belt for Fillflex filling machine
- Can be adapted to most packages and conveyor belts



For fully automated lines where a Fillflex filling machine is placed by a conveyor belt, we offer a complete solution, known as a queue and positioning unit, QP.

QP is available as an option for both Fillflex Compact and Fillflex Split filling machines.

The unit consists of two customised gates, as well as two photocells/sensors. The first gate is used to create a queue of packages prior to the filling position. The second gate is used to position the package correctly below the product outlet in the filling position. The unit holds the package by the filling station until the filling is complete. After filling, the package is released and the next package is forwarded. This continues in a precise and rapid process.

The gates consist of adjustable pneumatic cylinders with stainless steel brackets, which are adapted to the customer's package size and the width of the conveyor belt. They are monitored from the control system, and each function can be set with timer delays in respect of

start and release.

The properties of the photocell's/sensor's are selected according to the material, size, colour, etc., of the packaging.

Settings are made from a 4.3" touch panel, where the relevant function can also be run manually for adjustment and tuning.

It is important to ensure that the conveyor belt is of a "low friction" type, so that the package can be stopped and held in place while the conveyor belt is still in operation. Excessive friction on the conveyor belt may cause packages to get trapped or overturn.

The control system for QP can be supplied in a separate control cabinet with a control panel for adjusting and monitoring functions, or be integrated in a Fillflex Split cabinet, type Large. If the line is equipped with a separate control cabinet for BFE, the QP function can also be integrated in this.

Order number Fillflex BFE:

Complete kits for bottom filling, excl. filling lance.
Max. length 500 mm.

FF_BFE-TT-00	Bottom filling, Electric	Table Top, integrated
FF_BFE-TT-01	Bottom filling, Electric	Table Top, separate control cabinet
FF_BFE-ST-00	Bottom filling, Electric	Split Trolley, integrated
FF_BFE-ST-01	Bottom filling, Electric	Split Trolley, separate control cabinet
FF_BFE-QP-ST-00	BFE and queue management	Split Trolley, integrated
FF_BFE-QP-ST-01	BFE and queue management	Split Trolley, separate control cabinet

Filling lances, connection SMS25

FF_VF-L-25G8-300-V-1	ø=8 - l=300 mm
FF_VF-L-25G12-300-V-1	ø=12 - l=300 mm
FF_VF-L-25G16-300-V-1	ø=16 - l=300 mm
FF_VF-L-25G20-300-V-1	ø=20 - l=300 mm
FF_VF-L-25G25-300-V-1	ø=25 - l=300 mm

Communication kit for installation in existing or new machines.

FF_ACC-CK-01	Communication kit, for BFE in separate control cabinet
--------------	--------------------------------------------------------



Order number Fillflex QP:

Complete kits for queue management, incl. gates and photocell/sensor.

FF_QP-ST-00	QP queue management, Split Trolley, integrated
FF_QP-ST-01	QP queue management, Split Trolley, separate control cabinet

Communication kit for installation in existing or new machines.

FF_ACC-CK-01	Communication kit, for QP in separate control cabinet
--------------	-------------------------------------------------------



Fillflex™ Accessories

Suggested kits

When you buy your first Fillflex filling machine, it can be difficult to know initially how to configure your machine. For this reason, we have assembled the most commonly occurring parts in kits for you.

Inlet hoses and suction lances

In order to feed product to the filling machine, we have a number of different hose kits adapted for various applications. In many cases, the application or placement of the machine requires additional pipe fittings or other components. See separate section with pipe fittings.

Order number:

Suction pipe kit complete with 750 or 1200 mm long suction lance, 1 m hose and SMS25 or 38 connection.

FF_AI-SL25-750PN	Suction lance kit, SMS25, l=750	FDA, Plutone
FF_AI-SL25-1200PN	Suction lance kit, SMS25, l=1200	FDA, Plutone
FF_AI-SL38-750PN	Suction lance kit, SMS38, l=750	FDA, Plutone
FF_AI-SL38-1200PN	Suction lance kit, SMS38, l=1200	FDA, Plutone

Suction hose kit complete with 2 m hose, check valve with strainer and SMS25 or 38 connection. Not suitable for food.

FF_AI-SH25PVC	Suction hose kit, SMS25	l=2000 mm	check valve
FF_AI-SH38PVC	Suction hose kit, SMS38	l=2000 mm	check valve

Product hose kit complete with 2 m hose and SMS25 or 38 connection at both ends.

FF_AI-PH25-2000PN	Product hose SMS25	l=2000, FDA, Plutone
FF_AI-PH38-2000PN	Product hose SMS38	l=2000, FDA, Plutone



Suction lance kit for food



Suction hose kit with check valve

Hoppers

A product hopper can be used for small batches or when the product has a high viscosity and is difficult to feed into the pump. Hoppers are also used, in combination with a feed system when there are high demands in respect of accuracy in larger batches / continuous filling.

Order number:

FF_AI-H10-25	Hopper, 10 litres, with SMS25 connection
FF_AI-H10-38	Hopper, 10 litres, with SMS38 connection
FF_AI-HL10	Lid for 10 litre hopper



Flexible outlet pipes, outlet pipe kits and filling hoses

We can offer a wide variety of pipe kits, hoses and accessories for customising the machine's outlet side. Everything from basic, small, flexible outlet pipes to more complicated pipes for optimal customisation. Additional options for a tailor-made solution can be offered by using our pipe fittings. See chapter Pipe fittings.



Flexible outlet pipe

Order number:

Flexible outlet pipe for simple adjustment for different packages. Can be combined with various ejectors or outlet valves. Complete including pipe fittings and gaskets.

FF_AO-FOC25	Flexible outlet pipe, SMS25	Compacter
-------------	-----------------------------	-----------

Outlet pipe kit for Split machines, complete with pipe fittings, gaskets and pipe supports.

Can be combined with various ejectors or outlet valves.

FF_AO-FOS25-1	Outlet pipe kit, SMS25 type 1	M, 28 & OP12 pumps
FF_AO-FOS25-2	Outlet pipe kit, SMS25 type 2	M, 28 & OP12 pumps
FF_AO-FOS25-3	Outlet pipe kit, SMS25 type 3	BFE system
FF_AO-FOS38-1	Outlet pipe kit, SMS38 type 1	OP13-OP23
FF_AO-FOS38-2	Outlet pipe kit, SMS38 type 2	OP13-OP23

Check valve complete with SMS25 at both ends, nut on inlet and thread on outlet

FF_AO-VNC25	Check valve SMS25
FF_AO-VNF25	Check valve SMS25 Food grade

Outlet hose complete with outlet pipe at angle, 2 m hose, electric starter handle and SMS25 connection.

FF_AO-FHS20	Outlet hose SMS25/20, electric start	l=2000, FDA Plutone
FF_AO-FHS25	Outlet hose SMS25, electric start	l=2000, FDA Plutone
FF_AO-FHC25	Outlet hose with submerged tube	with check valve



Outlet hose with electric starter handle



Outlet hose with submerged tube and non-return valve

Accessories for control system

External Control Panel

If you mount your Fillflex on a wall or in a location where the operator cannot reach the built-in panel, an external control panel can be supplemented. This allows the operator to achieve full control over the filling machine without any interruptions to production.

Order number:

FF_F6600OP



Foot pedal, pneumatic

Can be placed under your workbench or on the other side of a conveyor belt, and activates filling with a simple press of your foot.

For manual start. No electricity. Simple and safe.

Order number:

FF_6210-OB



Starter handle

If you are filling large cans or heavy / bulky packages, it may be easier to fill your package with a outlet hose with an electric start handle.

Electric starter handle. Mounted on outlet hose and outlet pipe. Cable length 4 metres. IP54

Order number:

FF_TFA10145-EL-S8 (diameter 25 mm)
FF_TFA10145-EL-38-S8 (diameter 38 mm)



Trolley, mounts, pipe brackets and table tops

The placement and installation of your filling machine are often very important, and represent a crucial factor in order for the work to be carried out efficiently and ergonomically. We have a standardised range of trolleys, stands and mounts that are suitable for the vast majority of our applications and various Fillflex filling machines, with or without options.

Trolley Classic Compact

Trolley adapted for our Compact Filling Machine. Can be supplemented with table top and options such as BFE and QP, in separate control cabinet.

Order number:

FF_AS-TCC-01 (LxWxH) 660x600x1140



Trolley Classic Split

Trolley for our Fillflex Split machines. Can be supplemented with table top and options BFE and QP in separate control cabinet, as above.

Order number:

FF_AS-TC-01 (LxWxH) 660x600x1140



Trolley Large

For Split and Compact filling machines with space for further equipment, e.g. BFE Duplex bottom filling, DUO (two Fillflex panels in one cabinet), two pumps, or other bulky accessories.

Order number:

FF_AS-TL-01 (LxWxH) 770x600x1140



Trolley Small

For feed systems with control and pump. Suitable for all our feed pump applications.

Order number:

FF_AS-TS-01 (LxWxH) 500x470x1140



Wall mount, Split Wall

Fits our F5500 and F6600 Split cabinets if you have opted for the Split Wall variant, where the control cabinet is mounted against a wall, as an alternative to mounting on a Trolley.

Order number:

FF_AS-BW-200 for cabinets with c-c 200 mm

Table tops

Available in three different designs with the same dimensions, length 800 mm, width 300 mm. Complete with supports for mounting on one of our Trolleys above. Perfect work surface for semi-automatic filling. The table can be raised and lowered, and can be adjusted to a wide variety of package heights.



Order number:

FF_AS-TTS-300x800	Table top, stainless steel
FF_AS-TTP-300x800	Table top, plastic
FF_AS-TTPG-300x800	Table top, plastic with package fixture, (w=45–300 mm)
FF_AS-TTPGD-300x800	Table top Duplex, plastic with package fixture, (w=45–300 mm)

Package fixture for stand

Package fixture for mounting on one of our Trolleys. Suitable for combining with a stainless steel table or when a machine with a Trolley is positioned adjacent to a workbench.

Order number:

FF_AS-GS-01 incl. sensor for starter signal

Pipe bracket

Flexible pipe bracket for 25 or 38 mm pipes. Used in the vast majority of cases to stabilise product outlets on a Split Machine mounted on a Trolley. Particularly important if the product outlet has a filling valve. Easily adjustable in terms of both angle and height. Maximum length from stand 300 mm.



Order number:

FF_AS-SP-25	for 25 mm pipe
FF_AS-SP-38	for 38 mm pipe

Support legs for pipes

Suitable for supporting pipes that have been placed over e.g. a packaging machine, when there is a product outlet with multiple valves for a Fillflex Sequence filler.



Order number:

FF_AS-SPS-25 for ø25 pipes, max length 300 mm

Filling valves & ejectors

One of the many advantages of the Fillflex system is the ability to manage the entire filling process in detail. By providing the filler with a controllable valve, Fillflex is also able to fill traditionally “difficult” media such as foaming products or products with solid pieces. For highly foaming products, there is a bottom filler, where the filling lance is lowered to the bottom of the package before filling starts. Together with Fillflex’s control system, the bottom filler provides extremely fast and efficient filling. In many cases, a filling valve also provides more secure operation, without subsequent dripping. The dosing is also very even, including at high production rates.



Many basic products from a technical filling perspective can easily be filled without controllable filling valves. An ejector and an outlet pipe are enough. To avoid subsequent dripping, an ejector with drip protection can be installed in some cases. In such cases, the product must not contain particles, which will clog up the mesh in the ejector. In cases where even safer and faster operation without subsequent dripping is required, the machine can be equipped with a pneumatically controlled outlet valve with valve control.

Cone valve, internal, pneumatic

Cone valve that opens widely. Equipped with sensor that opens the valve before filling begins, not suitable for products containing pieces.

Order number:

FF_VF-C-25M25-06-V	(SMS25, ø6 mm outlet)
FF_VF-C-25M25-08-V	(SMS25, ø8 mm outlet)
FF_VF-C-25M25-10-V	(SMS25, ø10 mm outlet)
FF_VF-C-25M25-12-V	(SMS25, ø12 mm outlet)
FF_VF-C-25M25-14-V	(SMS25, ø14 mm outlet)
FF_VF-C-25M25-16-V	(SMS25, ø16 mm outlet)
FF_VF-C-25M38-18-V	(SMS25, ø18 mm outlet)
FF_VF-C-25M38-20-V	(SMS25, ø20 mm outlet)
FF_VF-C-25M38-25-V	(SMS25, ø25 mm outlet)
FF_VF-C-38M51-38-V	(SMS38, ø38 mm outlet)



Hose valve, pneumatic

An all-round valve that can handle most media. Suitable for packages with a large opening and for products with pieces.

Order number:

- FF_VF-H-25-09 (connection SMS25, ø9 mm hose)
- FF_VF-H-25-12 (connection SMS25, ø12 mm hose)
- FF_VF-H-25-16 (connection SMS25, ø16 mm hose)
- FF_VF-H-25-20 (connection SMS25, ø20 mm hose)
- FF_VF-H-25-25 (connection SMS25, ø25 mm hose)
- FF_VF-H-38-38 (connection SMS38, ø38 mm hose)



Hose valve, full-bore valve pneumatic

With extra large opening, suitable for products with large pieces.

Order number:

- FF_VF-HF-25-25 (connection SMS25, ø25 mm hose)
- FF_VF-HF-38-38 (connection SMS38, ø38 mm hose)



Diaphragm valve

Filling valve in diaphragm version for small volumes.

Order number:

- FF_VF-M-25-4 (connection SMS25, ø4 mm outlet)
- FF_VF-M-25-6 (connection SMS25, ø6 mm outlet)
- FF_VF-M-25-8 (connection SMS25, ø8 mm outlet)



Ejector with drip protection

Order number:

- FF_TFA10125-8 (diameter 8 mm)
- FF_TFA10125-10 (diameter 10 mm)
- FF_TFA10125-12 (diameter 12 mm)
- FF_TFA10125-16 (diameter 16 mm)
- FF_TFA10125-20 (diameter 20 mm)
- FF_TFA10125-25 (diameter 25 mm)

Add:

Outlet pipe, adjustable
(order no. FF_AO-FOC25)



Pipe fittings

We have a large “toolbox” including pipes, transitions, connections, check valves, strainers, etc., to satisfy all possible setups and requirements. The selection is based on our many years’ experience of filling and pump technology. For example, a check valve is a practical accessory that prevents the product from flowing back into the storage tank.

Bend

Order number:

- FF_TFA10165-25 (diameter 25 mm)
- FF_TFA10165-38 (diameter 38 mm)
- FF_TFA10165-51 (diameter 51 mm)



Pipe

Order number:

- | | |
|------------------------------------|------------------------------------|
| 25 mm pipe: | 38 mm pipe: |
| FF_TFA10185-25-1 (length 100 mm) | FF_TFA10185-38-1 (length 100 mm) |
| FF_TFA10185-25-2 (length 200 mm) | FF_TFA10185-38-2 (length 200 mm) |
| FF_TFA10185-25-3 (length 300 mm) | FF_TFA10185-38-3 (length 300 mm) |
| FF_TFA10185-25-4 (length 400 mm) | FF_TFA10185-38-4 (length 400 mm) |
| FF_TFA10185-25-5 (length 500 mm) | FF_TFA10185-38-5 (length 500 mm) |
| FF_TFA10185-25-X (length 0–600 mm) | FF_TFA10185-38-X (length 0–600 mm) |

- 51 mm pipe:
- FF_TFA10185-51-1 (length 100 mm)
 - FF_TFA10185-51-2 (length 200 mm)
 - FF_TFA10185-51-3 (length 300 mm)
 - FF_TFA10185-51-4 (length 400 mm)
 - FF_TFA10185-51-5 (length 500 mm)
 - FF_TFA10185-51-X (length 0–600 mm)



Hose nipple/Ejector bend 90°

Order number:

- | | |
|-------------------|----------------------------------|
| FF_TFA10194-25-20 | 25 mm nut/20 mm hose connection* |
| FF_TFA10194-25-25 | 25 mm nut/25 mm hose connection* |
| FF_TFA10194-25-32 | 25 mm nut/32 mm hose connection* |
| FF_TFA10194-25-38 | 25 mm nut/38 mm hose connection* |
| FF_TFA10194-38-25 | 38 mm nut/25 mm hose connection* |
| FF_TFA10194-38-38 | 38 mm nut/38 mm hose connection* |
| FF_TFA10194-38-51 | 38 mm nut/51 mm hose connection* |
| FF_TFA10194-51-25 | 51 mm nut/25 mm hose connection* |
| FF_TFA10194-51-38 | 51 mm nut/38 mm hose connection* |
| FF_TFA10194-51-51 | 51 mm nut/51 mm hose connection* |



*excl. nut

Hose connection/ejector standard

For connecting hoses to SMS connections or in order to be used as an ejector/filling nozzle.
Nut must be ordered separately, unless otherwise indicated.

Order number:

FF_TFA10195-25-08	Hose connection SMS25 - ø8 mm
FF_TFA10195-25-10	Hose connection SMS25 - ø10 mm
FF_TFA10195-25-12	Hose connection SMS25 - ø12 mm
FF_TFA10195-25-16	Hose connection SMS25 - ø16 mm
FF_TFA10195-25-20	Hose connection SMS25 - ø20 mm
FF_TFA10195-25-25	Hose connection SMS25 - ø25 mm
FF_TFA10195-38-38	Hose connection SMS38 - ø38 mm
FF_TFA10195-51-38	Hose connection SMS51 - ø38 mm
FF_TFA10195-51-51	Hose connection SMS51 - ø51 mm



SMS nut

SMS nut for use in combination with pipe fittings without nuts, such as hose connections and nipples.

Order number:

FF_272-25	Nut SMS25
FF_273-38	Nut SMS38
FF_273-51	Nut SMS51



Gasket

Rubber gaskets for use in combination with SMS pipe fittings. The standard material is food grade Nitrile.

Order number:

FF_273-25	Gasket SMS25 NITRILE FDA
FF_273-25E	Gasket SMS25 EPDM FDA
FF_273-25	Gasket SMS25 NITRILE FDA
FF_273-25E	Gasket SMS25 EPDM FDA
FF_273-38	Gasket SMS38 NITRILE FDA
FF_273-38E	Gasket SMS38 EPDM FDA
FF_273-51	Gasket SMS51 NITRILE FDA
FF_273-51E	Gasket SMS51 EPDM FDA



Hose connection adapter

Order number:

FF_TFA10195-25.32	(25 mm SMS / 32 mm hose connection) – nut included
FF_TFA10195-25.38	(25 mm SMS / 38 mm hose connection) – nut included
FF_TFA10195-38.51	(38 mm SMS / 51 mm hose connection) – nut included
FF_TFA10195-38.63	(38 mm SMS / 63 mm hose connection) – nut included



U-bend

Order number:

FF_TFA10200-25	(for 25 mm hose connection)
FF_TFA10200-38	(for 38 mm hose connection)
FF_TFA10200-51	(for 51 mm hose connection)



Adapter

Order number: Nut:

FF_TFA10170-38.25	(38 mm nut / 25 mm thread) excl. nut	FF_272-25
FF_TFA10170-51.38	(51 mm nut / 38 mm thread) excl. nut	FF_272-38



Adapter

Order number:

FF_TFA10175-25.38	(25 mm nut / 38 mm outer thread) nut included
FF_TFA10175-25.51	(25 mm nut / 51 mm outer thread) nut included
FF_TFA10175-38.51	(38 mm nut / 51 mm outer thread) nut included



Adapter SMS/BSP

Order number:

FF_TFA10210-25.25	(25 mm SMS nut / 25 mm BSP outer thread)
FF_TFA10215-25.25	(25 mm SMS thread / 25 mm BSP outer thread)



Hose nipple with thread

Order number:

FF_R-144-3.4" (19 mm thread/19 mm hose)
 FF_R-144-1" (25 mm thread/25 mm hose)
 FF_R-144-1,5" (38 mm thread/38 mm hose)



Butterfly valve

Order number:

FF_TFA10230-25.25-1 - without handle
 FF_TFA10230-38.38-1 - without handle
 FF_TFA10230-51.51-1 - without handle

Order number:

Handle FF_61670-15.51



Pneumatic actuator

Order number:

FF_PPW for 25 mm
 FF_PPQO for 38 and 51 mm

Bracket for pneumatic actuator

FF_681-25 for 25 mm PPW
 FF_681-38 for 38 and 51 mm PPOO



Check valves

Order number:

FF_74700 25SXX* Food grade
 FF_74700 38SXX* Food grade
 FF_0625.0602-1"-25 Non food grade



*The same number XX is adapted to connection and direction when ordering

Strainer

Intended for check valve FF_0625.0602-1"-25

Order number:

FF_IT-102-1"-25



Product hoses

We have a range of hoses that are suitable for different products. The hoses are sold by the metre, except in the case of hoses for valves, where the length is adjusted.

Hose, Plutone

Food grade hose available in sizes from 20 mm to 50 mm. A very durable hose, but is heavy and rigid and is best suited to fixed installations. Spiral reinforced. Max. temperature 100°C.

Order number:

FF_1348-20 (20 mm)
 FF_1348-25 (25 mm)
 FF_1348-32 (32 mm)
 FF_1348-38 (38 mm)
 FF_1348-50 (50 mm)



Hose, PVC

An affordable PVC hose for a wide variety of chemical products. Also approved for drinking water, but not generally suitable for food. Spiral reinforced. Max. temperature 60°C.

Order number:

FF_1336-19 (20 mm)
 FF_1336-25 (25 mm)
 FF_1336-38 (38 mm)
 FF_1336-50 (51 mm)



Hose, silicone

Spiral reinforced flexible hose in sizes 16, 19 and 25. Food grade. Withstands temperatures up to 180°C.

Order number:

FF_1071-16 (16 mm)
 FF_1071-19 (19 mm)
 FF_1071-25 (25 mm)



Valve hose, Bioprene

Valve hose that can be ordered in the exact length, suitable for our hose valves. The hose is food grade. Withstands temperatures up to 80°C.

Order number:

FF_903.0096.I32	9.6 x 3.2 mm
FF_903.0127.I32	12.7 x 3.2 mm
FF_903.0159.I32	15.9 x 3.2 mm
FF_903.0190.I48	19.0 x 4.8 mm
FF_903.0254.I48	25.4 x 4.8 mm



Valve hose, silicone

A smooth, flexible hose for Hose valve 38 mm. Transparent and withstands temperatures up to 180°C.

Order number:

FF_84202-1	38 x 48 mm
------------	------------



Fillflex™ Spare Parts

Fillflex has a comprehensive stock of spare parts in order to assist our customers rapidly with support. Performing scheduled maintenance on your machine is important for its function and reduces unexpected interruptions in production.



E-mail your question to us at ffspares@christianberner.com and we will help you. Please keep your serial number available.

For the Fillflex F5500, we have a replacement programme for panels. In our replacement system for Fillflex panels, you can get a refurbished panel from our warehouse at a reduced price by returning your defective panel within 30 days.

If you should experience any problems with your panel, please contact us for more information on how to proceed.

Maintenance kit

Order number	Machine type	Contains
FF_31499-CV200	Fillflex F5500xM200	O-rings, bushings & mechanical seal
FF_31499-CV210	Fillflex F5500xM210	O-rings, bushings & mechanical seal
FF_31499-CV220	Fillflex F5500xM220	O-rings, bushings & mechanical seal
FF_SK376-0105	Fillflex F5500x28220	O-rings & mechanical seal
FF_SK377-0105	Fillflex F5500x28320	O-rings & mechanical seal
FF_KL1DU	Fillflex F5500xOP12/13	O-rings & mechanical seal
FF_KL2DU	Fillflex F5500xOP22/23	O-rings & mechanical seal
FF_KL3DU	Fillflex F5500xOP32/33	O-rings & mechanical seal

Fillflex™ Service

Our service team is involved in projects right from the start, in order to gain a rapid overview of the requirements and what needs to be done to achieve a good result.

The installation of equipment is booked in consultation with you as the customer, and once the installation is completed, our technicians can also attend and monitor the start-up of production. Once fine-tuning is complete, we will hand the machine over to you.

Staff training is usually performed on your premises, in order for your personnel to get a good feel for the machine you have ordered.

If any damage occurs and your equipment breaks, we can either provide field service on site or you can send the equipment to our workshop for repair.



To get in touch with our service team, e-mail us at: ffservice@christianberner.com and we will get back to you as soon as we can.



Contact us

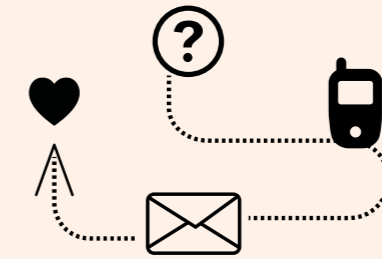

Head office & Sweden:

Christian Berner AB
info@christianberner.com
+46 31 33 66 900
christianberner.se

Denmark:

A/S Christian Berner
+45 70 25 42 42
infodk@christianberner.com
christianberner.dk

Finland:

Foilpak OY
+358 108 36 78 00
foilpak@foilpak.fi
Foilpak.fi

Norway:

Food:
Empakk
post@empakk.no
+47 69 32 69 10
empakk.no

Industry & Chemical:

Christian Berner A/S
+47 233 48 400
infono@christianberner.com
christianberner.no

Bakery:

Foodtech A/S
+47 22 08 70 70
post@foodtech.no
Foodtech.no





CHRISTIAN BERNER

Expect more