

## Original usage manual

### WOMA Series 52Y High Pressure Pump

LEUCO Type XX3010SR, TXX3010SL,  
TXX2410SR, TXX2410SL

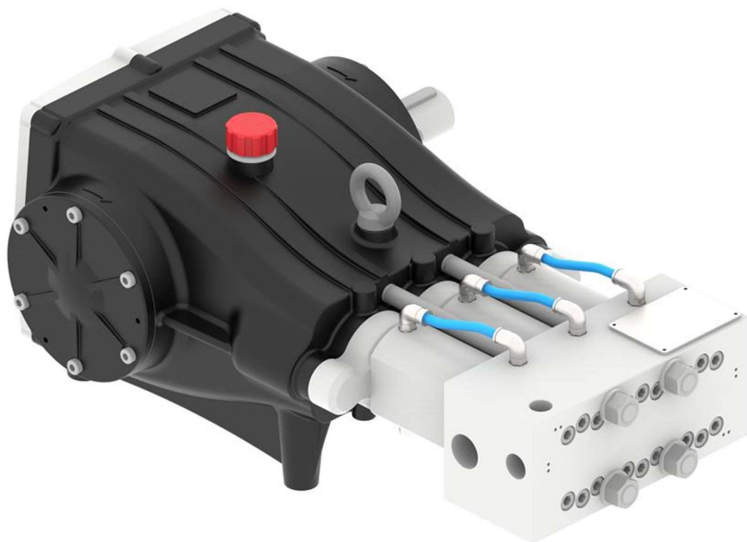

V 1.0 IT

(01/22)

**Contents**

<b>1</b>	<b>General information.....</b>	<b>5</b>
1.1	Information about these operating instructions .....	5
1.2	Manufacturer .....	5
1.3	Assistance .....	5
1.4	Formal Instruction Data .....	6
1.5	Representation Conventions .....	6
1.5.1	Instructions and Actions.....	6
1.5.2	Operating steps.....	6
1.5.3	Checklists.....	6
1.6	Abbreviations and definitions.....	7
<b>2</b>	<b>Safety.....</b>	<b>8</b>
2.1	Warnings.....	8
2.2	Representation of Safety Warnings.....	8
2.2.1	Hazard Warnings.....	8
2.3	Staff qualification .....	10
2.3.1	Operating requirements for staff .....	10
2.3.2	Requirements for maintenance staff .....	10
2.3.3	Requirements for trained qualified staff.....	10
2.4	Standard use .....	11
2.5	Foreseeable misuse .....	11
2.6	Pictograms.....	12
2.7	Spare parts and parts subject to wear and tear .....	12
<b>3</b>	<b>Technical data.....</b>	<b>13</b>
3.1	Labelling .....	13
3.2	Conditions of Use.....	13
3.3	Dimensions.....	13
3.4	Power.....	14
3.5	Substances .....	15
3.6	Weights .....	16
3.7	Connections .....	16
<b>4</b>	<b>Description of the operation 17</b>	
4.1	Operation sequence.....	17
4.2	Pump components .....	18
4.2.1	Mechanical unit .....	19
4.2.2	Gasket kit.....	20
4.2.3	Pump head.....	21

## Contents



<b>4.3</b>	<b>Accessories and options .....</b>	<b>22</b>
<b>4.4</b>	<b>Connecting pipes .....</b>	<b>23</b>
4.4.1	Supply line pipes .....	23
4.4.2	Delivery pipes .....	24
4.4.3	Return pipes .....	24
<b>5</b>	<b>Transport and storage .....</b>	<b>25</b>
<b>5.1</b>	<b>Safety warnings .....</b>	<b>25</b>
<b>5.2</b>	<b>Measures to be taken before transport .....</b>	<b>25</b>
<b>5.3</b>	<b>Storage .....</b>	<b>26</b>
<b>6</b>	<b>Assembly/Installation .....</b>	<b>27</b>
<b>6.1</b>	<b>Safety warnings .....</b>	<b>27</b>
<b>6.2</b>	<b>Assembly .....</b>	<b>29</b>
6.2.1	Fixing of the pipe .....	30
<b>6.3</b>	<b>Interfaces .....</b>	<b>31</b>
6.3.1	Assembling the valve block / regulating tool .....	31
6.3.2	Connecting the pipes .....	32
<b>7</b>	<b>Operation .....</b>	<b>33</b>
<b>7.1</b>	<b>Safety warnings .....</b>	<b>33</b>
<b>7.2</b>	<b>Initial start up .....</b>	<b>33</b>
<b>8</b>	<b>Operation .....</b>	<b>37</b>
<b>8.1</b>	<b>Safety warnings .....</b>	<b>37</b>
<b>8.2</b>	<b>Requirements for operation .....</b>	<b>38</b>
<b>8.3</b>	<b>Start .....</b>	<b>39</b>
8.3.1	Operating pressure control .....	39
<b>9</b>	<b>Support in case of failure .....</b>	<b>40</b>
<b>9.1</b>	<b>Contacts in case of failure .....</b>	<b>40</b>
<b>9.2</b>	<b>Table of faults .....</b>	<b>40</b>
<b>10</b>	<b>Maintenance and upkeep .....</b>	<b>42</b>
<b>10.1</b>	<b>Safety warnings .....</b>	<b>42</b>
<b>10.2</b>	<b>Routine maintenance and cleaning .....</b>	<b>43</b>
<b>10.3</b>	<b>Maintenance Plan .....</b>	<b>44</b>
<b>10.4</b>	<b>Description of Ordinary Maintenance Work .....</b>	<b>46</b>
10.4.1	Changing the oil .....	46
10.4.2	Checking fasteners and screw connections .....	48

---

<b>11</b>	<b>Shutting down.....</b>	<b>50</b>
11.1	Safety warnings.....	50
11.2	How to shut down.....	50
11.3	Frost protection / Treatment with a preservative product.....	50
<b>12</b>	<b>Dismantling .....</b>	<b>53</b>
12.1	Safety warnings.....	53
12.2	Preparation for dismantling .....	53
12.3	How to dismantle.....	53
<b>13</b>	<b>Disposal.....</b>	<b>53</b>
<b>14</b>	<b>Indices 54</b>	
14.1	Index of Figures.....	54
14.2	Index of Tables .....	54
<b>15</b>	<b>Annex.....</b>	<b>55</b>
15.1	Water quality 55	
15.2	Consumables.....	56
15.3	Dimensional drawings.....	57
15.4	CE Compliance .....	58

- 1 General information
- 1.1 Information on these operating instructions



## 1 General information

### 1.1 Information on these operating instructions

The following operating instructions have been drawn up in accordance with Directive 2006/42/EU. They allow safe and efficient use of the 52Y / LEUCO high-pressure pump Type TXX3010SR, TXX3010SL, TXX2410SR, TXX2410SL (hereafter referred to simply as 'pump').

The original operating instructions were written in Italian.

These operating instructions are an integral part of the pump and must be kept in its immediate vicinity and be accessible to operating personnel at all times.

### 1.2 Manufacturer

WOMA GmbH  
Werthausener Straße 77-79  
47226 Duisburg  
Germany  
Tel: +49 2065-304-0  
Fax: +49 2065-304- 200  
E-mail: [info@woma.kaercher.com](mailto:info@woma.kaercher.com)  
[www.woma-group.com](http://www.woma-group.com)

### 1.3 Assistance

For any technical information on WOMA products and their technical system applications, our customer service is at your disposal, worldwide.

Should you experience any difficulties with our products, please contact the WOMA service department, the relevant representatives or the manufacturer's factory, who will be happy to assist you.

WOMA GmbH  
Werthausener Straße 77-79  
47226 Duisburg  
Germany  
Tel: + 49 2065-304- 222  
Fax: + 49 2065-304- 200  
E-mail: [service@woma.kaercher.com](mailto:service@woma.kaercher.com)  
[www.woma-group.com](http://www.woma-group.com)

	<p>We can only help you quickly and process your order correctly if you provide your order number and serial number.</p> <p>We recommend that you record the two pieces of information below in the following fields:</p> <p>Order number: .....</p> <p>Serial number: .....</p>
---	--

## 1.4 Formal Instruction Data

Version/Revision: 1.0  
 Created on: 11.1.22

© Copyright, 2022 All rights reserved.

Reprinting, even in part, is only permitted with the express permission of WOMA GmbH.

## 1.5 Representation Conventions

### 1.5.1 Instructions and Actions

The operational steps to be performed are represented as a numbered list. The sequential order of actions must be adhered to.

Example:

1. Operating step 1
2. Operating step 2

### 1.5.2 Operating steps 6

Operating steps that have no mandatory sequential order are represented as lists of points.

Example:

- Operating step
- Operating step

### 1.5.3 Checklists

Checklists are represented as lists consisting of a list of points.

Example:

- Point 1
- Point 2

## 1 General information

### 1.6 Abbreviations and



---

### 1.6 Abbreviations and definitions

Below, when reference is made to the "right/centre/left" of the pump, this refers to the pump seen from the front, looking towards the pump head.

The term 'system' refers to the technical device the pump is mounted on, including all necessary technical (safety) devices such as (safety) valves, pipes as well as monitoring and control functions.

## 2 Safety

The pump complies with the Machinery Directive 2006/42/EC and has therefore been designed, manufactured and tested in accordance with the laws and technical safety standards, as well as the current state of the art.

Upon delivery, the pump is in impeccable technical condition.

However, the pump may constitute a hazard if:

- it is not used by specialised personnel with appropriate training.
- it is used improperly or in a manner not in accordance with its intended use.
- its condition is not technically perfect.

### 2.1 Warnings 8

To guarantee the safety and health protection of the staff that will operate the pump, the following must be ensured:

- all safety and hazard warnings are placed on the pump and are legible.
- there is suitable fire protection at the place of installation.
- after major repairs and conversions, the pump is tested again for safety.

### 2.2 Safety Warnings

#### 2.2.1 Hazard Warnings

- Compliance with these warnings protect against personal injury or material damage.
- The keyword indicates the level of danger.
- The keywords indicate the risk of personal injury.
- They indicate the type and source of danger.
- They designate the risk and possible consequences.
- They indicate the measures to be taken to avoid dangers and prohibit certain behaviour.



 <b>AVVERTIMENTO</b>	<p><b>Source of danger</b></p> <p>Possible consequences in the event of non-compliance</p> <ul style="list-style-type: none"> <li>– Measures / Prohibitions</li> </ul>
---	--

**Danger signs**

A danger sign characterises hazard warnings that refer to the risk of personal injury.

**Source of danger**

The source of the danger indicates the cause of the danger

**Possible consequences in the event of non-compliance**





The possible consequences in the event of non-compliance with the hazard warning are e.g. crushing, burns or other serious injuries.

**Measures / Prohibitions**

Measures/prohibitions refer to actions which must be performed in order to avoid a hazard (e.g. stopping the drive) or actions which are prohibited in order to avoid a hazard.

**List of keywords**

Table 1: Keywords

 <b>PERICOLO</b>	This keyword indicates imminent danger. If this danger is not avoided, it will result in serious injury or even death.
 <b>AVVERTIMENTO</b>	This keyword indicates a possible danger. If this danger is not avoided, it will result in serious injury or even death.
 <b>ATTENZIONE</b>	This keyword indicates a potentially dangerous situation. If this dangerous situation is not avoided, it may lead to minor or medium injuries.
<b>AVVISO</b>	This keyword indicates actions to prevent material damage. Damage to or breakage of the pump can be avoided by observing these warnings.
	Notice of useful and important information or advice to help improve safety when handling the pump.

**Commentato [LM1]:** Diciture non editabili:

PERICOLO = DANGER  
AVVERTIMENTO = WARNING  
ATTENZIONE = CAUTION  
AVVISO = NOTICE

## 2.3 Staff qualification

The personnel must have the relevant qualifications to operate, maintain and repair the product.

The scope of the personnel's responsibility, competence and control must be precisely defined by the operator.

Any gaps in the preparation of personnel must be filled through training and education.

### 2.3.1 Operating requirements for staff

The operating personnel are those persons who have been commissioned by the operator to operate the pump and who have received appropriate training in its use and operation.

The operating personnel must be familiar with the operation and mode of action of the pump, be able to recognise and prevent potential dangers by taking appropriate protective measures.

Operating personnel must be able to recognise dangers at an early stage and take action to eliminate them.

It is the duty of the operating personnel to notify the operator immediately of any changes to the pump that may affect its safety.

### 2.3.2 Requirements for maintenance staff

The maintenance personnel are the designated persons and the operator of the pump for installation and maintenance tasks. The maintenance personnel are not trained, but have nevertheless received instruction in control and maintenance operations, e.g. for oil changes, checking screw connections, etc.

The maintenance personnel must be familiar with the operation and mode of action of the pump, be able to recognise and prevent potential dangers by taking appropriate protective measures.

It is the duty of the maintenance personnel to notify the operator immediately of any changes to the pump that may affect its safety.

### 2.3.3 Requirements for trained qualified staff

Trained qualified personnel are defined as persons who have been trained by WOMA GmbH in inspection, maintenance and service operations and have received the necessary instructions regarding maintenance during training courses. Trained qualified personnel must be familiar with the operation and mode of action of the pump, be able to recognise potential hazards that arise and prevent them by taking appropriate protective measures.

## 2.4 Standard use

The pump is to be used for high-pressure water production exclusively. Operation without a pumped substance is prohibited.

The pump may only be operated in the presence of a suitable safety device that prevents the maximum operating pressure from being exceeded.

The pump may only be incorporated into systems that meet the requirements of the pump in all respects. The pump is designed for continuous operation at a permissible operating pressure of 1,000 bar. When using switching valves with high water hammer, a maximum operating pressure of 1,100 bar is permissible.

The pump is designed for operation as a single pump. Any use which could cause water hammers stronger than those caused by the pump itself (e.g. operation in a system consisting of several pumps on one discharge pipe) must be agreed with WOMA GmbH in advance.

The pump may only be operated with water without the addition of cleaning agents (see Chapter 3 - Technical Data and Annex 15.1 - Water Quality). Never switch on the pump without a sufficient water supply.

Flammable, toxic, corrosive or other dangerous liquids may not be pumped without explicit authorisation from WOMA GmbH.

Regular use also includes the exclusive use of original WOMA GmbH spare parts.

Any use that goes beyond or deviates from what is defined as the intended use is not permissible.

Observe safety and hazard warnings as well as local and national regulations.

## 2.5 Foreseeable misuse

- Use of the pump without an adequate safety device to prevent exceeding the maximum operating pressure.
- Using the pump with substances other than water.
- Use of the pump with unauthorised additives.
- Failure to comply with recommended maintenance times.
- Using the emergency switch of the system on which the pump is mounted for normal shutdown. The emergency switch only serves to quickly bring the pump/system into a safe state in the event of danger.





### AWISO

Incorrect configuration and use of the system can lead to premature wear, destruction of the pump and other system parts, e.g. valves or fittings.

## 2.6 Pictograms

Pictograms that are affixed on to the product but are no longer legible must be replaced.

Table 2: Pictograms

Pictogram	Description
	Read and understand the manual before operating the product
	Crush hazard warning
	Warning of danger from hot surfaces
	General danger symbols

## 2.7 Spare parts and parts subject to wear and tear

Using spare parts and part subject to wear and tear from third parties can cause a risk. Only use original WOMA GmbH parts or parts approved by WOMA GmbH.

3 Technical  
3.1 Data



**3 Technical Data**

**3.1 Labelling**

Table 3: Labelling

Company Name	Value
Machine name	High pressure pump
Serial number	The serial number can be found on the identification plate.

The identification plate (Figure 1) is located on the pump head.

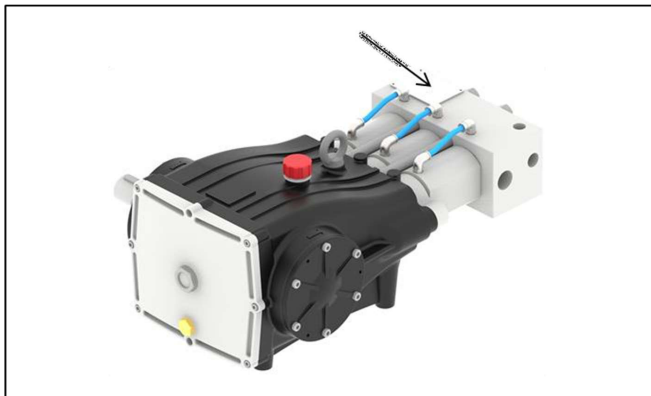

Figure 1: Location of the name plate (similar image)

**3.2 Conditions of Use**

Table 4: Conditions of Use

Company Name	Value
Room temperature	min. +5 °C max. +45 °C

**3.3 Size**

Table 5: Size

Pump	Length x Depth x Height
WOMA 52Y LEUCO TXX3010SR LEUCO TXX3010SL LEUCO TXX2410SR LEUCO TXX2410SL	687.5 mm x 422 mm x 262 mm

See also the dimensioned drawing in Annex 15.3

### 3.4 Power

Table 6: Power

Company Name	Value
Overall power requirements 52Y, TXX2410SR, TXX2410SL (52 mm stroke) max.	(at permissible operating pressure) 46 kW
52Y, TXX3010SR, TXX3010SL (60 mm stroke) max.	52 KW
Permissible operating pressure max. under continuous load conditions	1,000 bar
Maximum operating pressure for max. 120 manoeuvring pulses / h	1,100 bar
Capacity 52Y, TXX2410SR, TXX2410SL (52 mm stroke) max.	25 l/min
52Y, TXX3010SR, TXX3010SL (60 mm stroke) max.	29 l/min
Drive speed min.	1,000 rpm 500 rpm
Pair 52Y, TXX2410SR, TXX2410SL (52 mm stroke) max.	(at the drive shaft) 431 Nm
52Y, TXX3010SR, TXX3010SL (60 mm stroke) max.	497 Nm
Sound pressure level emitted according to DIN EN ISO 11203	>80 dB(A)

### 3 Technical

#### 3.5 Data



### 3.5 Substances

Table 7: Substances

Company Name	Value
Water supply pressure min. max.	(relative pressure data) 1.0 bar 5.0 bar
Maximum permissible pressure amplitude (in operation)	± 2,0 bar
Water temperature min. max.	+5 °C +45 °C (higher temperatures on request)
Water supply requirement min.	1.75 times the nominal capacity of the pump depending on the seal kit
Water quality	See attached water quality directive 15.1
Oil quantity in the crankcase	5.5 l
Oil viscosity as per ACEA A3; ACEA B4; ACEA E2; API SL; API CF; API CG-4	15 W - 40
Oil temperature max. Nominal value	80 °C 60 - 70 °C



Observe the WOMA water quality directive for high-pressure pumps in the latest valid version (for an excerpt, see appendix 15.1).

### 3.6 Weights

Table 8: Weights

Company Name	Mass
Total weight 52Y, TXX2410SR, TXX2410SL (52 mm stroke) approx.	88.9 kg
52Y, TXX3010SR, TXX3010SL (60 mm stroke) approx.	88.7 kg
Mechanical unit 52Y, TXX2410SR, TXX2410SL (52 mm stroke) approx.	40.4 kg
52Y, TXX3010SR, TXX3010SL (60 mm stroke) approx.	40.2 kg
Gasket kit approx.	12.1 kg
Pump head approx.	36.4 kg

The data refer to the version with oil filled and without optional accessories.

### 3.7 Connections

Table 9: Connections

Company Name	Value
Inlet connection (suction pipe)	G1"
Inlet connections	M24x1"
Pressure gauge / safety valve	G1/2"
Drive Shaft	Diameter 40 mm k6, Tongue according to DIN 6885 sheet 1, A12 x 8 x 70



## 4 Description of the operation

### 4.1 Operating sequence





## 4 Description of the operation

The pump is a plunger type with a screwed head. It can be incorporated into a high-pressure water-jet machine.

For example, the pump can be used to clean objects with a water jet, using cold water, without the addition of cleaning agents.

The pump is driven directly via an elastic coupling, via a gearbox or a universal joint.

V-belt drives are generally permitted, for exact configuration please contact WOMA GmbH.

	If the maximum drive power is transmitted via a V-belt, the life cycle of the shaft bearings may be reduced.
	With these pumps, the direction of rotation of the drive is predefined. If a reverse direction of rotation is required, please contact WOMA GmbH to inquire about the necessary technical measures.

### 4.1 Operating sequence

1. Water is channelled to the pump from a reservoir via a centrifugal pump, or there is a direct supply via the domestic water supply.
2. A water filter traps unwanted impurities that might otherwise cause premature wear of the device.
3. The rotational movement of the drive motor is converted into an oscillating piston movement in the pump via a crankshaft.
4. The suction and delivery movements of the pistons impart high pressure to the water via the suction and delivery valves.
5. Different operating pressures can be achieved by means of a pressure regulating device, depending on the pump type and piston diameter.
6. Water leaves the pump via a high-pressure hose and is led to a utilisation device.
7. Utilisation devices can be high-pressure guns with nozzles, lances or hoses with nozzles, etc.

## 4.2 Pump components

The pump consists of three main groups: mechanical unit (Figure 2: Position 1), gasket set (Figure 2: Position 2) and pump head (Figure 2: Position 3):

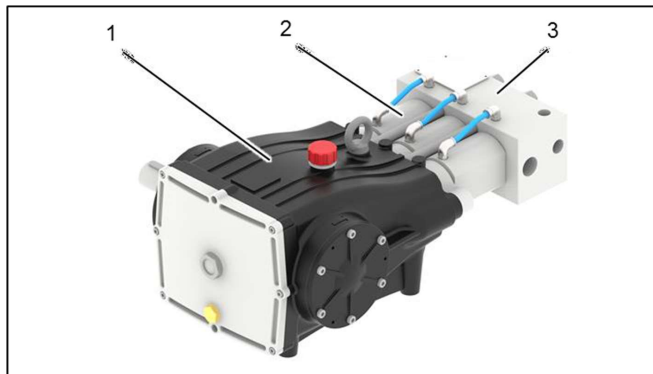

Figure 2: Main pump assemblies

- 1 Mechanical unit
- 2 Gasket kit
- 3 Pump head

## 4 Description of the operation

### 4.2 Pump components



#### 4.2.1 Mechanical unit



Figure 3: Mechanical unit

- 1 Oil breather plug
- 2 Crankcase cover
- 3 Oil level sight glass
- 4 Oil drain plug
- 5 Crankcase

The mechanical unit contains a 3-eccentric shaft. The rotation is transformed into an oscillating movement of the pistons through the eccentric shaft.

The connecting rods are driven via the shaft eccentrics. The bearings, piston guides and connecting rods are lubricated by a splash system.

#### 4.2.2 Gasket kit

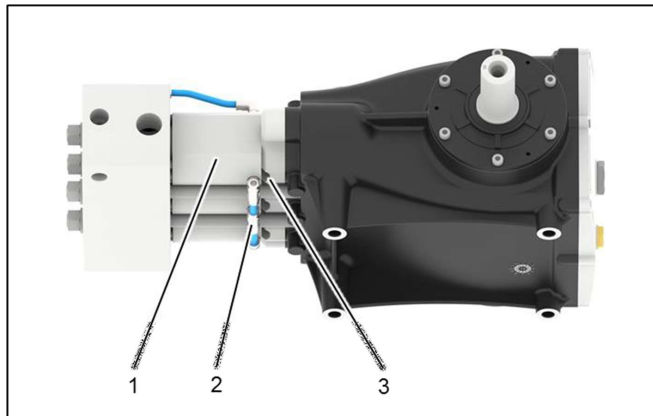

Figure 4: Gasket kit

- 1 Cylinder with seals and piston
- 2 Gasket recirculation system
- 3 Water leakage drainage lights

The gasket set consists of the cylinders (Figure 4: Position 1) with seals for high and low pressure as well as pistons. The pistons are attached to the piston guides by nuts.

The seal recirculation system is a low-pressure system installed for cooling, lubrication and sealing of the pistons. The gasket recirculation system is directly connected to the inlet manifold of the pump head. As soon as an inlet pressure is applied to the pump head, the piston is wetted with water at low pressure.

The gasket recirculation system (Figure 4: Position 2) must have a pump supply tank return.

If water escapes from the drainage lights (Figure 4: Position 3), the gasket set needs to be repaired.

## 4 Description of the operation

### 4.2 Pump components



#### 4.2.3 Pump head

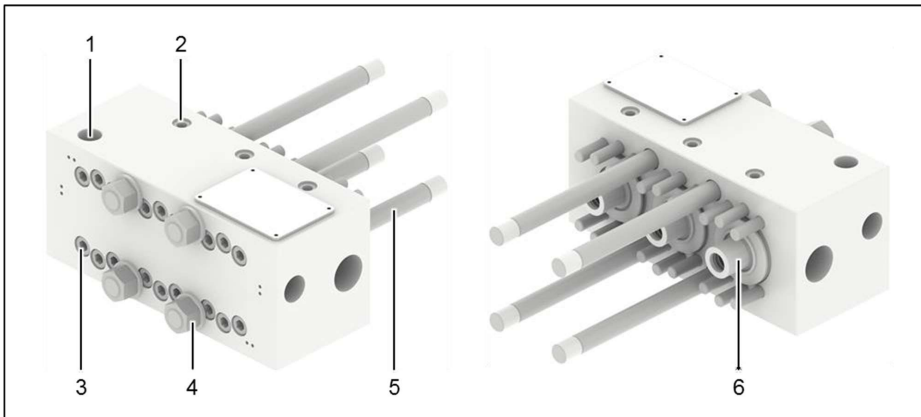

Figure 5: Pump head, front (left), back (right)

- |  |                |
|--|----------------|
| 1 Connecting the high-pressure gauge     | 4 4 Fixing nut |
| 2 Gasket recirculation system connection | 5 Hanger bolt  |
| 3 Fixing screw                           | 6 Valve system |

The valve system (Figure 5: Position 6) is installed in the pump head and contains the suction and discharge valves.

On the high-pressure gauge connection (Figure 5: Position 1), a pressure gauge is normally installed, on which the delivery pressure can be read.

Connection of the gasket recirculation system (Figure 5: Position 2) is for connecting the return line to the tank.

The pump head is screwed on with studs (Figure 5: Position 5) and nuts (Figure 5: Position 4) directly on the mechanical unit housing.

### 4.3 Accessories and options

The following accessories and options can be purchased and connected to the pump. If these have not already been fitted at the factory, please observe the assembly and operating instructions scrupulously.



Figure 6: Protection with rupture disk (similar image)

#### Safety device (protection with rupture disk)

Rupture disk protection protects the system from damage caused by overpressure: when the preset maximum pressure is exceeded, the rupture disk immediately opens fully, causing depressurisation.

- for operating pressure of 1,000 bar (9.920-452.0)

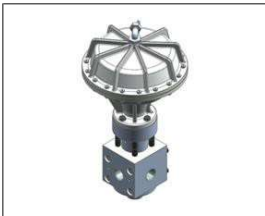

Figure 7: Pneumatic overflow valve (similar image)

#### Regulator (pneumatic control valve)

The pneumatically actuated regulating valve is a regulating device that serves to remotely control the pressure to the relevant operating conditions and to switch high pressure on or off. The water pressure can be adjusted directly from the workstation.

- 2/2-way valve, pneumatic, max. at 1,500 bar (9.871-149.0)
- Outlet connection M24x1.5(9.896-449.0)



Figure 8: Manual overflow valve (similar image)

#### Regulator (manual control valve)

The pneumatically actuated regulating valve is a regulating device that serves to remotely control the pressure to the relevant operating conditions and to switch high pressure on or off.

- 2/2-way valve, pneumatic, max. at 1,500 bar (9.906-937.0)
- Outlet connection M24x1.5(9.896-449.0)



Figure 9: Manometer

#### High pressure monitoring

The pressure gauge is used to directly control the operating pressure.

- max. 1,270 bar operating pressure, visual (9.882-792.0)
- Connection fitting for pressure gauge (9.907-214.0)
- sensor monitoring(6.025-114.0)

## 4 Description of the operation

### 4.4 Connecting pipes



#### 4.4 Connecting pipes

The perfect functioning of a high-pressure pump system depends to a large extent on the correct dimensioning and laying of the supply and discharge pressure lines, as well as their connections.

Before being connected and used, all pipes (flexible and rigid) must be cleaned internally.

##### 4.4.1 Supply pressure pipes

The supply pressure pipes must be constructed so that no air can enter. All unscrewable connections must be carefully sealed. No sealing problems should occur as a result of vibrations.

To avoid the transmission of mechanical vibrations, the connection from the system to the pump must be made with flexible piping.

Supply pipes must be laid in an upward direction to avoid air bubbles. A vent must be applied at the highest point of the pipe. For longer horizontal sections, a vent must be installed approximately every 3 m. The minimum size of the vent is G1/2".

In the inlet pipes, the water must not exceed a maximum velocity of **1.4 m/s**. The occurrence of resonance in the system's inlet pressure pipe can usually be eliminated by lengthening the inlet pressure pipe itself.

Elbows, sudden and sharp-edged changes to the pipe cross-section must be avoided in order to keep flow resistance in the pipe to a minimum.

During operation, the shut-off valves in the supply pipes must be fully open and, as a result of vibrations or other similar influences, must not close independently.



Shut-off valves must not be used to regulate the inlet pressure.

Centrifugal feed pumps must remain in operation before switching on and after switching off the high-pressure pump. The achievable flow rate according to the pump's characteristic diagram must be at least 1.75 times the pump's flow rate.

Compliance with the pump supply pressure must be monitored with a deactivating device.

The piping system of the supply line must be equipped with suitable pressure flow stabilisers or other sufficiently dampening devices to ensure a homogeneous flow to the suction valves under all operating conditions.

The pipes from the filter should be made of non-corrosive material, so that no rust particles can reach the pump.

A supply tank should be installed to drain the water and to collect the return from the control valves.

If there is return piping from control valves, ensure that the temperature in the tank does not exceed permissible values. If necessary, a certain amount of cold substance should always be fed into the device.

The pipe system should be configured with as few fittings and bends as possible. If no guidelines have been issued by the manufacturer, do not exceed a bending radius of 2.5xD.

#### 4.4.2 Delivery pipe lines

All components, pipes and pipe connections that are under pressure must be correctly dimensioned for the maximum permissible operating pressure. The velocity in the high-pressure line must never exceed **8 - 10 m/s**.

Flexible pipes must be laid so that no damage can occur as a result of mechanical effects or vibrations.

All delivery pipes must withstand the mechanical, chemical and thermal stresses that arise.

The pump must be decoupled from the discharge pipe so that the pulsation in the discharge manifold of the pump head does not exceed  $\pm 8\%$  of the operating pressure. The pulsations depend substantially on the structure of the system and their usage must therefore be controlled.

#### 4.4.3 Return piping / suction pipe

All components, pipes and pipe connections must be correctly designed for the maximum operating pressure.

A feed tank should be installed to collect the return water from the gasket recirculation system.

Velocities in the return pipes should not exceed 3 m/s.



## 5 Transport and storage

### 5.1 Safety warnings



## 5 Transport and storage

### 5.1 Safety warnings

#### **AVVERTIMENTO**

#### **Suspended loads**

The slinging point is only intended for lifting the pump. When the pump unit (pump with motor) is transported by means of this slinging point, there is a danger of falling due to overloading.

- Use the pump slinging point exclusively for pump transport.
- Use appropriate means of slinging and catching the load.
- The pump may only be transported by qualified personnel.

### 5.2 Measures to be taken before transport

- Disconnect all connecting pipes.
- Drain the water from the pump (see Chapter 11.3).
- Assess the mass of the load, its centre of gravity and possible behaviour during transport and use suitable slinging and lifting gear

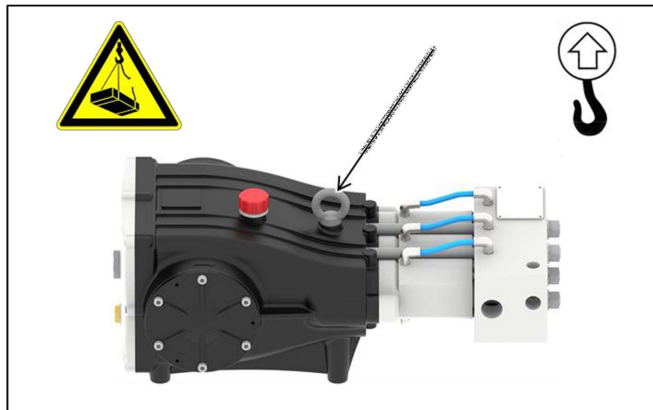

Figure 10: Lifting eyebolt

- Only lift the pump from the slinging point provided for transport (Figure 10).

### 5.3 Storage

Only store the pump if the following conditions apply:

- all openings must be closed.
- Do not store outdoors.
- Store in a dry and dust-free place.
- Do not expose the pump to aggressive substances (e.g. salt air).
- The storage temperature must be between +5 °C and +45 °C.
- The relative air humidity must have a maximum value of 60%.
- Store the pump with a suitable protective medium (see Chapter 11.3 - Frost Protection / Treatment with a Protective Product )



The factory-applied protective product on newly delivered pumps is designed to last about 6 months.

- If the machine is stored for more than 3 months, the coating should be checked at regular intervals with protective products and any signs of rusting should be refreshed or renewed if necessary.



For pumps that are stored for more than 6 months, we recommend turning the drive shaft at regular intervals.

- after storage for more than 18 months, wear parts fitted in the pump (e.g. seals, etc.) must be replaced before operation
- Do not store wear parts (e.g. seals, etc.) for more than 36 months.

## 6 Assembly/Installation

### 6.1 Safety warnings



## 6 Assembly/Installation

### 6.1 Safety warnings

 <b>AVVERTIMENTO</b>	<b>Pressurised liquids</b> In the event of a failure of pressurised components, there is a danger of the pressurised fluid hitting someone. <ul style="list-style-type: none"><li>– Ensure that all connections are adequate to withstand the pressure of the system.</li></ul>
---	--

 <b>AVVERTIMENTO</b>	<b>Flexible pipes</b> If flexible pipes are not secured properly, there is a danger of being hit by them. <ul style="list-style-type: none"><li>– Carry out a visual check of the pipes before tightening the fittings.</li><li>– Tighten the hoses as indicated by the manufacturer.</li></ul>
---	--

#### Flexible pipes

- The instructions of the flexible pipe manufacturer must be observed.
- The flexible pipe fastener must be securely attached.
- The pipes of the supply line must be absolutely tight and dimensioned according to the pressure of the supply line.
- The supply line pipes must be laid so as to prevent tripping.
- The pump must be connected via flexible piping to avoid the transmission of mechanical vibrations.

#### Pump

- The pump may only be installed by qualified personnel.
- The pump may only be mounted on a flat surface.
- The inclination of the pump must not exceed the maximum limit of 5°.

<b>AVISO</b>	The maximum inclined position of 5° of the pump in all directions also applies to mobile systems. Exceeding this threshold can cause serious damage to the pump.
--------------	--

- The frame on which the pump is installed must be manufactured so that it is stable and torsion-resistant.
- The pump must be accurately aligned with the drive unit.

- For the evaluation of permissible alignment errors, please refer to the manual provided by the coupling manufacturer.
- If the pump is installed in enclosed spaces (coverings, soundproofing bonnets and the like), it is imperative to ensure that the maximum ambient and oil temperatures prescribed for the pump are observed.
- When installing the pump, free space must be provided for the following maintenance and control functions:
  - Checking the oil level
  - Changing the oil
  - Pump drainage (in case of frost risk)
  - Clear view of gauge dials
  - Clear view of the earthing point
  - Visual inspection of components
  - Any work on the motor and coupling
- When installing the pump, be sure to collect any oil leaking from the shaft seals and piston guides, so that it does not escape into the environment. Provide a suitable collection device especially for mobile systems.
- If the pump is to be integrated into a fully automatic system, the oil pressure value must also be monitored automatically and/or displayed on the control system.
- Ensure sufficient sealing between components. No sealing problems should occur as a result of vibrations.
- Use suitable dampers to prevent the transmission of vibrations.
- Bolts or other fixing methods must be provided in such a way as to prevent unintentional displacement of the equipment.

## 6 Assembly/Installation

### 6.2 Mounting



### 6.2 Mounting

**PERICOLO**

#### Electrostatic charge / Current

Danger of electric shock in the event of contact with the housing.

- In order to prevent the build-up of electrostatic charges, equipotential bonding should be provided for the devices concerned, and using an earth conductor, if necessary.



Figure 11: Earth connection

The earth conductor can be mounted using a suitable M12 screw once the eyebolt has been removed.

Warnings concerning the earth conductor: During this operation, ensure that the grounding of the pump is not compromised by coatings, sheaths or the like.

### 6.2.1 Fixing the pump

The fastenings (Figure 12) of the pump to the system must prevent movement, but must not create abnormal tension.

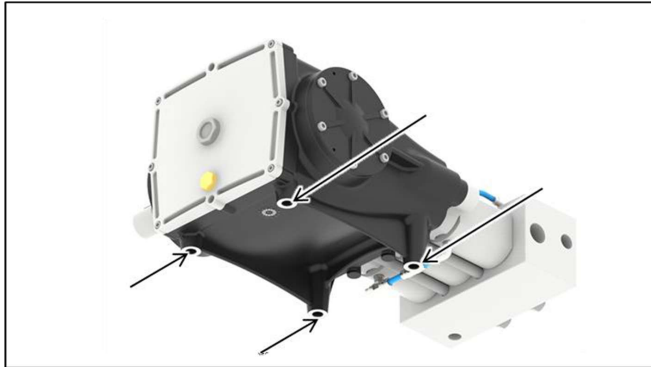

Figure 12: Fasteners

Use screws of a suitable length, strength and class to secure the pump. A screw insertion depth of at least 19 mm must be observed, with a maximum of 21 mm. The tightening torque for M16 screws can be found at Table 10: Tightening torque.

Table 10: Screws and tightening torques

Company Name	Value		
Screws	M16	M16	M16
Resistance class	8.8	10.9	12.9
Tightening torque (Nm)	150	150	150

### 6.3 Interfaces

The following picture shows the pump interfaces:

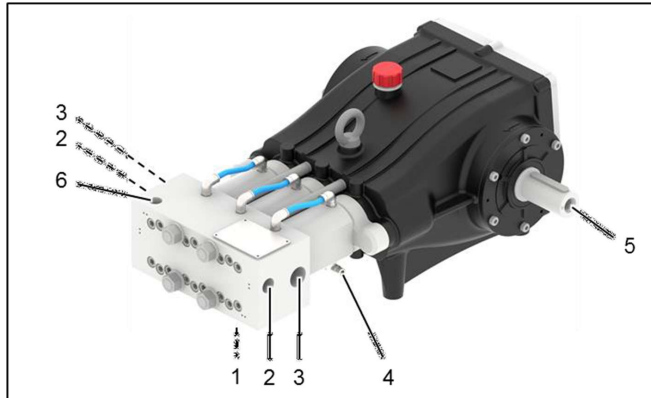

Figure 13: Pump interfaces (similar image)

- 1 High pressure sensor connection
- 2 Outlet connection (optionally right or left), usually valve block / regulating device
- 3 Power connection (optionally left or right, but possible on both sides)
- 4 Gasket recirculation system return (to be connected to a return line to the tank)
- 5 Drive shaft (right-hand drive as standard)
- 6 Connecting the high-pressure gauge

#### 6.3.1 Assembling the valve block / regulating tool

The valve block / regulating device are installed separately.  
We recommend installing them as close to the pump head as possible. Assembling the valve block / regulating tool,  
4.3 - Accessories and options

### 6.3.2 Connecting the piping



The high-pressure line may only be connected when a flange or a regulating device is mounted on the high-pressure side (see Chapter 6.3.1 - Assembling the Valve Block/Control Device).

1. Connect the pipes as shown in Figure 13. We recommend using flexible pipes to avoid the transmission of vibrations.
2. The supply line must have a minimum amount of pressure (see Table 7:Substances). If necessary, a centrifugal pump must be fitted. The water must be filtered according to water quality. Contact WOMA GmbH for an offer on centrifugal pumps and compatible filters.
3. (Automatic) bleed valves are recommended for venting water. A G1" fitting is required for connecting the inlet pressure line (see Figure 13: Position 3). A M24x1.5 fitting is required for connecting the inlet pressure line (see Figure 13: Position 2). In addition, pipe fasteners must be used.
4. Check the connections of the pump pipes, including the gasket recirculation system pipes.





## 7 Operation

### 7.1 Safety warnings



## 7 Operation

### 7.1 Safety warnings

 <b>AVVERTIMENTO</b>	<p><b>Pressurised liquids</b></p> <p>In the event of a failure of pressurised components, there is a danger of the pressurised fluid hitting someone.</p> <ul style="list-style-type: none"><li>– Ensure that all connections are adequate to withstand the pressure of the system.</li><li>– Never connect vent valves on the discharge side.</li><li>– The pump may only be commissioned by suitably trained qualified personnel.</li><li>– Protection against exceeding the max. operating pressure must be implemented by means of a safety device.</li><li>– Never switch on the pump without a sufficient water supply.</li></ul>
 <b>AVVERTIMENTO</b>	<p><b>Noise</b></p> <p>Depending on the intended use and type of drive, there is a risk of damage to hearing.</p> <ul style="list-style-type: none"><li>– Wear appropriate hearing protection.</li></ul>
<b>AVVISO</b>	<p>After storage for more than 18 months, wear parts fitted in the pump (e.g. seals, etc.) must be replaced before operation. Operation after the storage period has been exceeded can cause serious damage to the pump itself.</p>

### 7.2 Initial start up

As a rule, the pump is delivered with the crankcase oil filled. The pump head was treated with a preservative against corrosion.

Under special delivery circumstances, e.g. transport by air, the pump is delivered without oil filling. The internal parts of the pump and pump head are treated with a corrosion protection product.

The protective product must not be rinsed off before filling the oil.

- The warning signs on the pump must be observed.
- Check the oil level of the pump before commissioning.



For control via the oil level sight glass, the pump must be placed in a horizontal position.  
The nominal oil level is in the centre of the sight glass.



Figure 14: First start-up (similar image)

- 1 Oil breather cap
- 2 Oil level sight glass
- 3 Connecting the high-pressure gauge
- 4 Outlet connection
- 5 Water supply connection

The pump is put into operation as follows:

1. Check the oil level via the sight glass (Figure 14): Position 2). Check the oil level via the sight glass(Figure 14):
2. If not enough oil is available, unscrew the oil breather plug (Figure 14): Position 1).
3. Fill with the prescribed amount of oil (Table 7:Oil quantity) according to specification (Table 13:Oils).
4. Screw the oil breather cap back on tightly.
5. Ensure that the supply pressure line is connected to the inlet connection.
6. Open (if fitted) the shut-off valves in the supply pressure line.
7. Fill the supply tank (if present).
8. Fill (if present) the centrifugal pump and (if present) the filter and vent both (observe the relevant instructions for use).

## 7 Operation

### 7.2 Initial start up



9. Connect the high-pressure gun or other consumers with a high-pressure hose to the delivery connection (Figure 14): Position 4) of the pump.



For flexible pipes and accessories compatible with our pump, see the accessories catalogue. All current offers are available on our website at [www.woma-group.com](http://www.woma-group.com).

10. Observe the maximum operating pressure of all components.
11. Adjust the supply pressure in the range of 1.0 to 5.0 bar (Figure 15), e.g. by adjusting the centrifugal pump (if fitted).

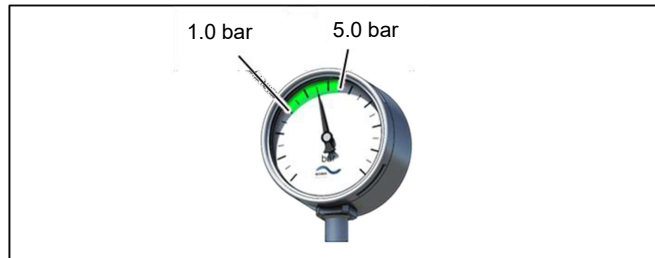

Figure 15: Pressure gauge on supply line

12. Check the tightness of all lines connected to the pump.



At this point the pump will be operational.

**AWISO**

During initial commissioning or after reinstalling the motor or its power cables, check the correct direction of rotation of the drive.



Figure 16: Standard direction of drive rotation for left and right pump





## 8 Operation

### 8.1 Safety warnings



## 8 Operation

### 8.1 Safety warnings

 <b>AVVERTIMENTO</b>	<b>Motorised components</b> <p>During the movement of the drives, there is a crushing hazard caused by the moving parts and a dragging hazard caused by the rotating parts.</p> <ul style="list-style-type: none"><li>- The drives can only be activated if they are adequately protected by suitable covers.</li></ul>
 <b>AVVERTIMENTO</b>	<b>Pressurised liquids</b> <p>When the pump is operated without overpressure protection, there is a danger of injury caused by the overpressure of the pump housing/pump head itself.</p> <ul style="list-style-type: none"><li>- Only operate the pump with sufficient overpressure protection.</li><li>- The technical data of the pump must be observed when configuring the overpressure protection.</li></ul>
 <b>AVVERTIMENTO</b>	<b>High pressure jet</b> <p>Depending on the range of use of the pump, there is a danger of water escaping and causing injury to third parties.</p> <ul style="list-style-type: none"><li>- The work area must be demarcated. Access must be impeded.</li><li>- The demarcated area must be protected from splashing water.</li><li>- Do not point the jet at people, animals, machines or electrical components.</li></ul>
 <b>AVVERTIMENTO</b>	<b>Insufficient pressure monitoring</b> <p>In the event of insufficient pressure monitoring, there is a danger of leakage or defective parts.</p> <ul style="list-style-type: none"><li>- Only operate the pump with a pressure monitoring system.</li><li>- The pressure monitoring system must display the maximum permissible operating pressure in addition to the working pressure.</li></ul>

 <b>AVVERTIMENTO</b>	<p><b>Hot oil</b></p> <p>Risk of serious burns from contact with hot oil.</p> <ul style="list-style-type: none"> <li>- Do not open the oil drain or the crankcase cover while the pump is in operation.</li> <li>- It is forbidden to operate the pump without the crankcase cover.</li> </ul>
---	--

 <b>ATTENZIONE</b>	<p><b>Hot surfaces</b></p> <p>Risk of minor burns from contact with pump surfaces.</p> <ul style="list-style-type: none"> <li>- Do not carry out maintenance work while the pump is in operation.</li> <li>- Do not touch surfaces when operating the pump.</li> </ul>
---	--

- Never switch on the pump without a sufficient water supply.
- If the pump is used without a noise cover, the member states' regulations on the environmental noise emission of machines and equipment intended for use outdoors (Directive 2000/14/EC) must be observed.
- The elements required for the operation of the pump and drive motor, e.g. electrical power, fuel, cooling and process water, must be adequately and constantly available.
- It is forbidden to exceed the values for pressure, flow rate, RPM and drive power given in this manual.
- If detergents are used, they must only be added to the delivery line.

## 8.2 Requirements for operation

During operation, the shut-off valves in the supply line must be fully open and, as a result of vibrations or other similar influences, must not close independently.

Shut-off valves must not be used for regulating the supply pressure.

Centrifugal pumps must remain in operation before switching on and after switching off the high-pressure pump.

During the entire operation, the supply pressure must be between 1.0 and 5.0 bar.

## 8 Operation

### 8.3 Start



Since the pump is a piston pump, a pulsation of the supply pressure is inevitably created during operation. The supply line must be equipped with pulsation dampeners or similar devices, so that a maximum variation of  $\pm 2.0$  bar is not exceeded.

A supply tank should be installed for venting water and for collecting the return from the control valves. The supply tank must guarantee the venting of water under all operating conditions.

In the case of return lines from the control valves in the supply tank, it must be ensured that the water temperature at the pump inlet does not exceed the permissible values.

When necessary, a certain amount of cold water should always be fed.

For coarse dirt, a filter must be connected upstream of the supply pipe, see chapter 15.1 - Water Quality.

Before starting the pump, the oil level must be visible in the centre of the sight glass (Figure 14): Position 2).

In the case of a cold start, the machine must be operated for about 3 minutes at idle before switching to high pressure mode to ensure that the oil is directed to all bearings.

After starting the machine, the operating pressure must be checked.

### 8.3 Start

#### 8.3.1 Operating pressure control

The operating pressure is checked at the pump head (Figure 14: Position 3) with a high-pressure gauge (Figure 9). For the maximum permissible operating pressure, see Table 6: Working pressure.

The desired operating pressure can be adjusted by means of the control valves, by changing the flow rate or by an appropriate choice of nozzles.

- The desired operating pressure can be adjusted continuously with a regulating valve (see Chapter 4.3 - Accessories and Options) up to the maximum permissible value, either manually or pneumatically.
- The flow rate can be changed by adjusting the drive speed. In this case, the minimum speed stated in Chapter 3.4 must be observed.

The operating pressure can be monitored electronically.

## 9 Support in case of failure

### 9.1 Contact in case of faults

WOMA GmbH  
 Werthausen Straße 77-79  
 47226 Duisburg  
 Germany  
 Tel: + 49 2065-304- 222  
 Fax: + 49 2065-304- 200  
 E-mail: [service@woma.kaercher.com](mailto:service@woma.kaercher.com)  
[www.woma-group.com](http://www.woma-group.com)

### 9.2 Table of faults

	If a fault cannot be solved using the relevant table, please contact the service personnel of WOMA GmbH (see chapter 1.3 - Service).
---	--

A troubleshooting help guide can be found in the following table. Unless otherwise indicated, responsibility for repairing the fault must be borne by qualified personnel. Unless otherwise indicated, responsibility for repairing the fault must be borne by qualified personnel 2.3 - Qualification of personnel).

Table 11: Table of faults

Fault	Cause	Fault Resolution	Person in charge
The high-pressure pump does not reach the required operating pressure	The high-pressure pipe is not tight	Check and replace if necessary	Qualified personnel
	The high-pressure gun or other utilities are defective	Check and replace nozzles	Qualified personnel
	Water quantity too low	Clean the water filter	Qualified personnel
	Insufficient water delivery pressure	Check the centrifugal pump and piping system	Qualified personnel
	Defective or non-tight safety device	Check or replace	Qualified personnel
	The inlet pressure system sucks in air	Making pipes watertight again	Trained qualified personnel
	Worn control valve	Perform maintenance on the control valve	Trained qualified personnel
	Defective valves	Replace valves	Trained qualified personnel
Worn gaskets	Dismantle and replace gasket set	Trained qualified personnel	



## 9 Support in case of failure

### 9.2 Table of faults



Table 11: Table of faults

<b>Fault</b>	<b>Cause</b>	<b>Fault Resolution</b>	<b>Person in charge</b>
The high-pressure pump makes abnormal noises during operation	Air in the supply pressure piping system	Vent or re-seal the supply pressure line	Qualified personnel
	Defective valves	Dismantling and replacing valves	Trained qualified personnel
	Vibrations / Pulsations in the supply or discharge pressure line	Check the effectiveness of damping devices, check whether valves are tight or worn	Trained qualified personnel
	Worn or damaged mechanical unit	Have the mechanical unit checked	WOMA service personnel
Leakage from seals	The seals are worn	Replace seals	Trained qualified personnel
	Low pressure seals leak	Replace the low-pressure seal	Trained qualified personnel
	Scuffed or damaged pistons	Replace pistons	Trained qualified personnel
	Damaged gasket housing	Replace gasket housing	Trained qualified personnel



## 10 Maintenance and upkeep

To ensure a long service life and trouble-free operation, the pump needs not only proper use but also regular care.

The pump must be regularly checked (inspection) and, in order to avoid consequential damage, any defects found must be rectified promptly.

- All maintenance work must only be carried out by qualified and trained personnel.
- All work can only be carried out on the machine that has been switched off and secured against restarting. The procedures for shutting down machines described in the operating manual (Chapter 11 - Shutting Down) must be strictly adhered to.
- Work on the pump in operation is prohibited.
- Ensure that no personnel working in the vicinity are endangered.

### 10.1 Safety warnings

 <b>AVVERTIMENTO</b>	<p><b>Pressure components</b></p> <p>If pressurised components are opened, there is a danger that the pressurised fluid will hit someone or that screws will be ejected.</p> <ul style="list-style-type: none"> <li>- Only carry out maintenance work when the pump is stopped and depressurised.</li> <li>- Ensure that the engine will not start/operate unintentionally.</li> </ul>
 <b>AVVERTIMENTO</b>	<p><b>Hot oil</b></p> <p>Risk of serious burns from contact with hot oil.</p> <ul style="list-style-type: none"> <li>- Allow the oil to cool before replacing it.</li> <li>- The oil change must be carried out in a stopped state.</li> <li>- During maintenance work with oil, wear protective goggles and oil-resistant safety gloves.</li> </ul>

10 Maintenance and upkeep  
10.2 Routine maintenance and cleaning



 <b>ATTENZIONE</b>	<p><b>Hot surfaces</b></p> <p>Risk of minor burns from contact with pump surfaces.</p> <ul style="list-style-type: none"><li>- Before starting maintenance work, allow the pump components to cool down.</li><li>- Wear suitable safety gloves.</li><li>- Do not carry out maintenance work during operation.</li><li>- Do not touch surfaces during operation.</li></ul>
---	---

**10.2 Routine maintenance and cleaning**

 <b>ATTENZIONE</b>	<p><b>Debris</b></p> <p>Danger of cutting injuries caused by debris inside the pump.</p> <ul style="list-style-type: none"><li>- Wear suitable safety gloves.</li></ul>
---	---

- Clean the pump when necessary.
- Do not use aggressive cleaning agents.
- Use lint-free rags.
- Before cleaning the pump, all openings where, for safety or functional reasons, no detergent can enter must be covered.
- The safety data sheets of the detergents must be observed.

### 10.3 Maintenance Plan

The following activities must be carried out by the operator in the specified time intervals (h = operating hours).

"Check" means that components must always be replaced, even if no fault is found. The necessary spare parts are included in the relevant wear parts packages.

The inspection of non-replaced components must be carried out from the date of the first inspection each time the machine is serviced.

Once a day and/or every 10 h	Check	Clean	Replace
Oil filling: check, top up if necessary (see chapter 10.4.1)	●		
Check from the outside if the pump has leaks in the oil or water circuit. In the event of oil leakage, the relevant seals must be replaced by specialised personnel.	●		
Warning signs: present and legible (replace if necessary)	●	●	

Once a week and/or every 50 h	Check	Clean	Replace
Mechanical unit and pump head: check for abnormal noises	●		
Clean the pump according to the level of soiling		●	

The first time after 50 h / always every 50 h after a repair as well as after every maintenance interval (see chapter 10.4.2)	Check	Clean	Replace
Fastening the cylinder and pump head to the crankcase: check tightening torque and presence of corrosion	●		
Pump fixing screws: check	●		
Check all connections of valves and fittings	●		

First time after 50 h	Check	Clean	Replace
Oil filling: drain the first filling and replace it (see Chapter 10.4.1)			●

## 10 Maintenance and upkeep

### 10.3 Maintenance Plan



The following activities must be carried out within the specified time intervals and only by qualified personnel. During training courses, qualified personnel trained at WOMA GmbH obtain the necessary information in the form of maintenance instructions.

<b>AWISO</b>	The carrying out of maintenance work by qualified personnel is a prerequisite for reliable and safe operation of the pump over time.
--------------	--

<b>AWISO</b>	The specified maintenance intervals represent the expected service life if our water guidelines are adhered to and the commissioning and maintenance work is carried out professionally. These values may vary upwards or downwards, under better or worse operating conditions,
--------------	--

<b>Once every 12 months and/or every 1,000 h (whichever comes first)</b>	Check	Clean	Replace
Changing the oil			●
Oil (6.288-050.0) [1 litre]			

<b>In addition every 12 months and/or every 2,000 h (whichever comes first)</b>	Check	Clean	Replace
Gasket housing: Check wear parts (pistons, ...)	●		
Gasket housing: Replace gasket pack (seals, force ring and valve springs)			●
Gasket housing: maintenance kit (9.919-918.0) - wear parts kit (9.741-735.0)			
Pump head: Check wear parts (valves, guide bushings)	●		
Pump head: Replace the maintenance kit (seals, valve springs, ...)			●
Pump head 52Y: maintenance kit (9.919-919.0) - wear parts kit (9.741-737.0)			
Clean the crankcase and check for leaks	●	●	
GE 52: Wear parts kit, piston guide oil seal (9.918-701.0) GE 52: Wear parts kit, crankcase cover O-rings and bearing flanges (9.918-843.0)			

In addition every 24 months and/or every 4,000 h (whichever comes first)	Check	Clean	Replace
Maintenance kit: Check wear parts (cylinders)	●		
Maintenance Kit: Wear Parts Kit (9.741-736.0)			
Pump head: Changing the maintenance kit (screws)			●
Pump head 52Y: maintenance kit (9.919-920.0)			

### 10.4 Description of routine maintenance work

The following points describe the necessary control and maintenance work that can be carried out by unqualified but trained personnel.

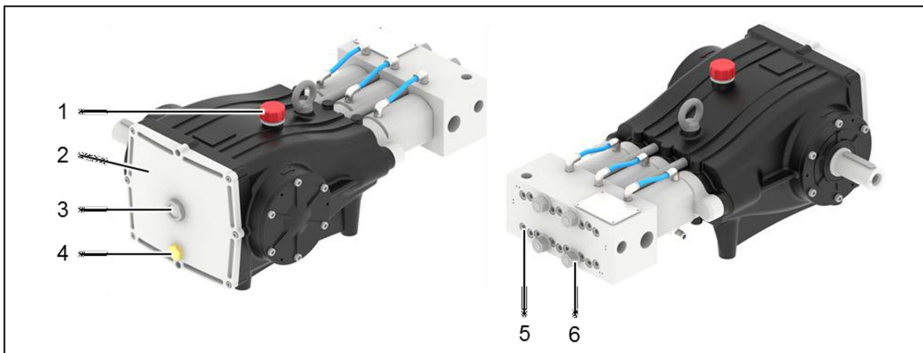



Figure 17: Components to be checked

- |                         |   |
|-------------------------|---|
| 1 Oil breather plug     | 4 Oil drain plug                            |
| 2 Crankcase cover       | 5 Fixing screw (gasket kit on pump head)    |
| 3 Oil level sight glass | 6 Fixing nut (pump head on mechanical unit) |

#### 10.4.1 Changing oil

	When changing oil for the first time, we recommend removing the crankcase cover and cleaning the oil sump of any deposits before filling with new oil.
	The oil change must be carried out when the pump is warm. For control via the oil level sight glass, the pump must be in a horizontal position.

1. Keep an oil container of sufficient size on hand to collect the used oil leaking from the screw cap (Figure 17): Position 4).

## 10 Maintenance and upkeep

### 10.4 Description of routine maintenance work



2. Unscrew the oil drain plug (Figure 17: Position 4).
3. Unscrew the oil breather plug (Figure 17: Position 1).
4. Drain the oil completely.
5. If necessary, clean the oil drain plug (Figure 17): Position 4) from metal residues.
6. If metal residues are present in the oil, unscrew the crankcase cover (Figure 17): Position 2) and check the inside of the crankcase for any damage.  
The WOMA service department will help you with the evaluation if needed.
7. Screw the oil drain plug back in (Figure 17): Position 4).
8. Check whether the discharged oil contains water (white emulsion).
9. If an emulsion is detected in the oil, replace the seals of the straight-line pistons. Check the piston seals (Figure 4: Position 3) to search for possible leakage defects.
10. Refit the crankcase cover (Figure 17): Position 2; if it has been opened).
11. Fill with the prescribed amount of oil (Table 7:Oil quantity) according to specification (Table 13:Oils) through the oil filling nozzle (Figure 17: Position 1).
12. Check the oil level via the sight glass (Figure 17): Position 3).



The nominal oil level is in the centre of the sight glass.

13. Screw the oil breather plug back on (Figure 17): Position 1).

**10.4.2 Checking fasteners and screw connections**



Figure 18: Components to be

checked Table 12: Torques and tightening order

	Fixing the cylinder	Fixing the pump head	Fixing the pump
Position in Figure 18	1	2	3
Screw / nut	M10 screws	M16 nuts	M16 screws
Quantity	18	4	4
Tightening order	Figure 19 Number 1 – 18	Figure 19 Number 19 – 22	-
Tightening torque (Nm)	40	35	150

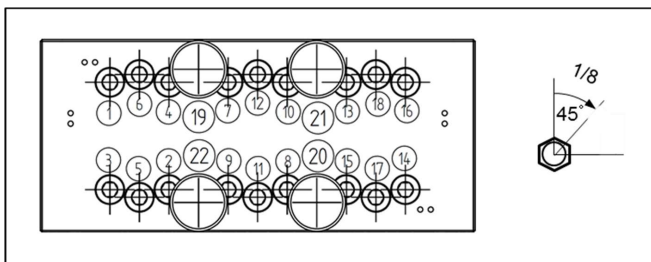

Figure 19: Screw connection tightening order



**AWISO**

In the event of a negative check, the screw connections of the cylinder and pump head must first be replaced.

**Checking the cylinder fixing  
(Figure 18): Position 1)**

1. Check the screws for corrosion.
2. Use a sufficiently large torque spanner for the check. The relevant tightening torque can be found in Table 12: Torques and tightening order.
3. Check that all tightenings are performed with a maximum of 45° rotation, according to the sequence in Figure 19: Tightening order of connections screw.

**Checking the attachment of the pump head to the crankcase  
(Figure 18): Position 2)**

1. Check nuts and studs for corrosion.
2. Use a suitable torque spanner for checking. The relevant tightening torque can be found in Table 12: Torques and tightening order.
3. Check that all tightenings are performed with a maximum of 45° rotation, according to the sequence in Figure 19: Screw connection tightening order.

**Checking the attachment of the pump to the crankcase  
(Figure 18): Position 2)**

1. Check the screws for corrosion.
2. Check the tightness of the screws with the help of a suitable tool. The relevant tightening torque can be found in Table 12: Tightening order and test torques. The screws securing the pump to the complete machine must prevent movement, without, however, creating abnormal stresses on the machine on which it is incorporated.

## 11 Shutting down

### 11.1 Safety warnings

 <b>ATTENZIONE</b>	<p><b>Oil</b></p> <p>Danger of skin and eye irritation caused by contact with oil.</p> <ul style="list-style-type: none"> <li>- When working with oil, wear protective goggles and oil-resistant safety gloves.</li> </ul>
---	--

### 11.2 How to shut down



Operations other than the following steps may be required depending on the specific installation. These are listed in the system manufacturer's operating instructions.

According to the regulations currently in force, the following procedure is recommended for decommissioning:

1. Reset the discharge pressure.
2. Switch off the engine.
3. Once the pump has stopped, switch off the inlet pressure.
4. Close the shut-off valves in the inlet pressure line.
5. Depressurise the pressure line.

### 11.3 Frost protection / Treatment with a protective product

In the event of temporary shutdown or danger of frost, the water must first be drained from the pump. If the pump has to be shut down for an extended period of time, all measures must be taken to enable smooth operation to resume afterwards. In this case, the expiry date of the protective product must be taken into account.

	WOMA preservative oil (5l drum material number 9.901- 464.0) offers protection for up to 6 months.
	In the event of danger of frost, a glycol-based antifreeze with anti-corrosion additives is recommended.
	The duration of the outage for which treatment with a protective product is required depends on the environmental conditions and the quality of the transported substance. As a rule, i.e. when the water quality meets the guidelines, treatment with a protective product should be carried out in the event of interruptions longer than three weeks.

## 11 Shutting down

### 11.3 Frost protection / Treatment with a preservative product

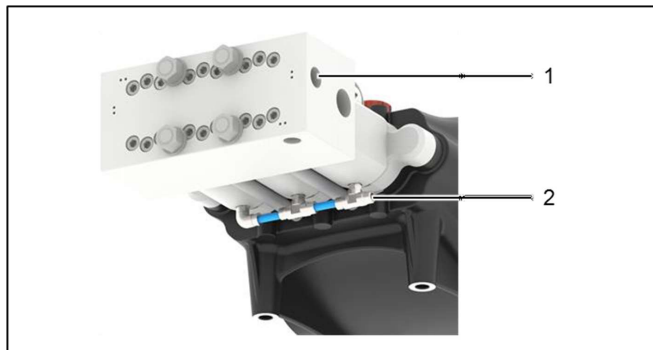

Figure 20: Emptying the pump

- 1 Plug on delivery connection
  - 2 Recirculation system water outlet
1. Aspirate the antifreeze fluid/protective product during the last work cycles of the pump. If an external recirculation system supply is switched on, also supply the recirculation system.
  2. Switch off the pump.
  3. Close the supply and discharge pipework of the pump to be protected/treated with protective product and depressurise the pipework.
  4. Keep a sufficiently large container on hand to collect the remaining antifreeze fluid/protective product.
  5. To empty the water from the header, remove the delivery plug (Figure 20): Position 1).
  6. Drain the control valve (see Chapter 4.3 - Accessories and Options).
  7. Disconnect all return lines (from the regulating valve, recirculation system (Figure 20: Position 2), etc.) and let the hoses/rigid hoses empty completely.
  8. Refit the cap on the delivery connection (Figure 20): Position 1).
  9. Drain the oil preferably while the pump is still warm (see Chapter 10.4.1 - Changing the oil).

 **ATTENZIONE**

**Falling objects**

Danger of crushing or catching falling objects from the pump.

- Before loosening the last screw, two screws of the crankcase cover must be replaced with threaded pins.

10. Remove the crankcase cover (Figure 3: Position 2).
11. Treat the crankcase housing and all its internal components from all sides with spray-on protective oil.
12. Refit the crankcase cover.
13. Install all return lines (of the control valve, the water recirculation system (Figure 20: Position 2) etc.) by fixing them in the appropriate places.
14. Mark the stored pump with a notice that the oil has been drained.

## 12 Dismantling

### 12.1 Safety warnings

 <b>ATTENZIONE</b>	<p><b>Oil</b> Danger of skin and eye irritation caused by contact with oil.</p> <ul style="list-style-type: none"><li>- When working with oil, wear protective goggles and oil-resistant safety gloves.</li></ul>
---	---

### 12.2 Preparation for dismantling

Before dismantling, secure all components to be loosened to prevent them from falling, toppling over or slipping.

- Only the persons in charge of the dismantling should be present in the work area.
- Ensure that all systems are depressurised.
- Prepare the necessary tools for dismantling work.
- Choose and keep suitable lifting devices, hooks, ropes and chains at hand.
- Ensure that all operating and auxiliary materials have been unloaded.

### 12.3 How to dismantle

Remnants of operating and auxiliary materials can still be found inside the various components. Therefore, before dismantling the components, piping, etc., keep suitably sized collection vessels on hand. Operating materials and leaking auxiliary materials must be collected and disposed of in accordance with current regulations.

## 13 Disposal

When disposing of the pump, as well as operating materials and auxiliary materials, the following points must be observed:

- Follow the national standards valid locally.
- Comply with company regulations.
- Dispose of operating and auxiliary substances in accordance with the relevant safety data sheets in force.

## 14 Indices

### 14.1 Indices of figures

Figure 1: Location of nameplate (similar image)	13
Figure 2: Main pump units	18
Figure 3: Mechanical unit	19
Figure 4: Gasket kit	20
Figure 5: Pump head, front (left), back (right)	21
Figure 6: Protection with rupture disk (similar image)	22
Figure 7: Pneumatic overflow valve (similar picture)	22
Figure 8: Manual overflow valve (similar picture)	22
Figure 9: Manometer	22
Figure 10: Eyebolt	25
Figure 11: Earth connection	29
Figure 12: Fasteners	30
Figure 13: Pump interfaces (similar picture)	31
Figure 14: First start-up (similar image)	34
Figure 15: Pressure gauge on supply line	35
Figure 16: Direction of rotation for left and right pump	36
Figure 17: Components to be checked	46
Figure 18: Components to be checked	48
Figure 19: Screw connection tightening order	48
Figure 20: Emptying the pump	51
Figure 21: Dimensional drawing	57

### 14.2 Index of Tables

Table 1: Keyword	9
Table 2: Pictograms	12
Table 3: Labelling	13
Table 4: Conditions of Use	13
Table 5: Dimensions	13
Table 6: Power	14
Table 7: Substances	15
Table 8: Weights	16
Table 9: Connections	16
Table 10: Screws and tightening torques	30
Table 11: Table of faults	40
Table 12: Tightening order and test torques	48
Table 13: Consumables	56

## 15 Annex

### 15.1 Water quality directive



## 15 Annex

### 15.1 Water quality

The WOMA water quality directive is available on request. Below is an extract with the basic requirements for feed water:

Standard filtration	≤ 10 µm
Total water hardness	3 - 15°H
CaO	30 - 150 mg/l
CaCO <sub>3</sub>	54 - 268 mg/l
Calcium hardness	0,89 - 2,14 mmol/l
PH value	6,5 - 9,5
Acidity (pH 8.2)	0 - 0,25 mmol/l
Percentage of all dissolved substances	10 - 75 mg/l
Electrical conductivity	100 - 450 µS/cm
Chlorides (e.g. NaCl)	< 100 mg/l
Iron (Fe)	< 0.2 mg/l
Fluoride (F)	< 1.5 mg/l
Free chlorine (Cl)	< 1 mg/l
Copper (Cu)	< 2 mg/l
Manganese (Mn)	< 0.05 mg/l
Phosphate (H <sub>3</sub> PO <sub>4</sub> )	< 50 mg/l
Silicates (Si <sub>x</sub> O <sub>y</sub> )	< 10 mg/l
Sulfate (SO <sub>4</sub> )	< 100 mg/l

## 15.2 Consumables

Table 13: Consumables

<b>Fats and assembly pastes</b>			
<b>Scope of application</b>	<b>Company Name</b>	<b>Drum</b>	<b>Material No</b>
Threads of screws and fittings	Thread Paste	500 g	9.892-362.0
		207 g tube	9.740-194.0
Fitting joints and more.	Anti-seize paste	450 g	9.892-352.0
		85 g tube	9.740-195.0
O-Ring	Silicone grease	100 g	9.890-524.0
		10 ml tube	9.740-196.0
<b>Oils</b>			
<b>Scope of application</b>	<b>Recommended oils</b>	<b>Drum</b>	<b>Material No</b>
Oil viscosity as per ACEA A3; ACEA B4; ACEA E2; API SL; API CF; API CG-4	15 W – 40	1.0 l	6.288-050.0
<b>Preservative and antifreeze products</b>			
<b>Scope of application</b>	<b>Company Name</b>	<b>Drum</b>	<b>Material No</b>
Stopping for an extended period of time	Preservative oil	5.0 l	9.901-464.0
Frost risk shutdown	Antifreeze	200 l	9.890-458.0



15.3 Dimensional drawing

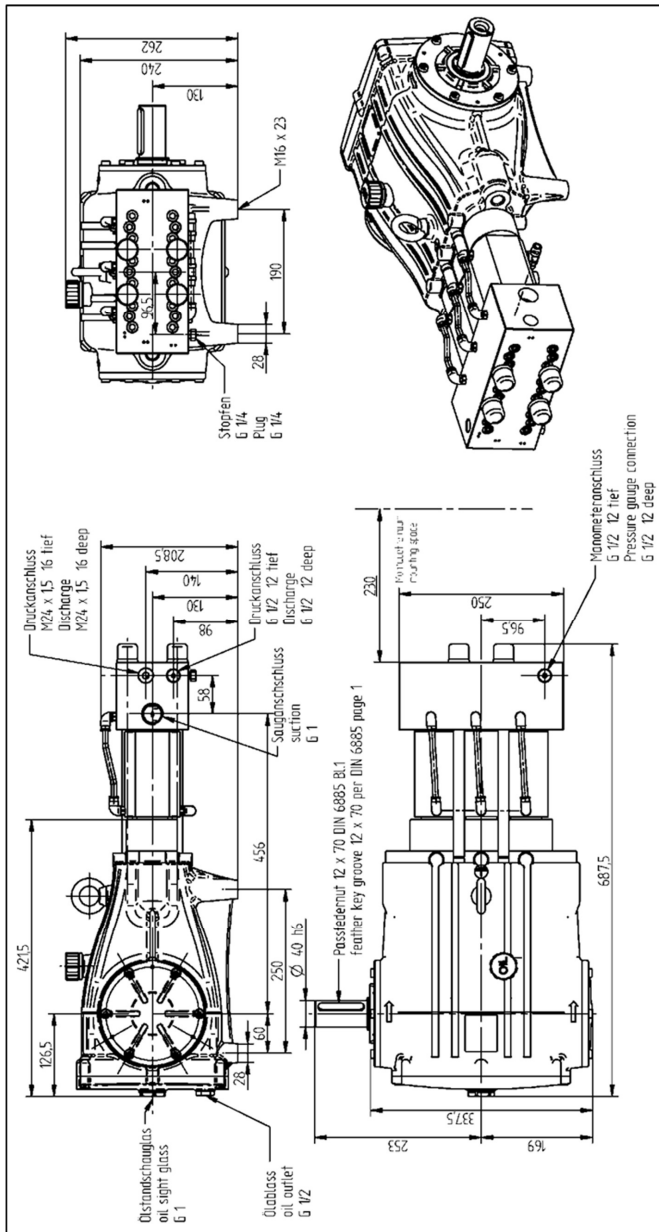



Figure 21: Dimensional drawing

## 15.4 CE Compliance

	<p>Dichiarazione di conformità CE originale per una macchina ai sensi della Direttiva 2006/42/CE, Allegato II, 1A</p>	
---	---	--

Nome ed indirizzo del produttore: **WOMA GmbH**  
**Werthausen Straße 77-79**  
**47226 Duisburg**  
**Germania**

Oggetto della dichiarazione

Denominazione commerciale: **Pompa a stantuffo tuffante ad alta pressione**

Modello: **52Y**

Tipo: **Pompa a stantuffo tuffante**

Funzione : **Serve per la creazione di acqua ad alta pressione, quando è collegato un utensile idraulico con ugello / ugelli o un dispositivo per la limitazione della portata.**

L'oggetto di cui sopra, è conforme a quanto indicato dalle norme armonizzate in vigore dell'Unione Europea:  
**Direttiva 2006/42/CE**

Si dichiara che le norme armonizzate in vigore, o altre indicazioni di ulteriori specifiche tecniche, alla base della conformità sono le seguenti:

EN ISO 12100:2010	Sicurezza del macchinario – Principi generali di progettazione – Valutazione del rischio e riduzione del rischio
EN 809:1998+A1:2009/AC:2010	Pompe e gruppi di pompaggio per liquidi – Requisiti generali di sicurezza

La responsabilità esclusiva per la redazione di questa dichiarazione di conformità ricade sul produttore.

**Produttore e responsabile per la compilazione dei documenti tecnici:**  
WOMA GmbH, Werthausen Straße 77-79, 47226 Duisburg, Germania

**Sottoscritto per e in nome di:**  
**WOMA GmbH**  
Germania, 47226 Duisburg, il 31/01/2022

  
.....  
(Ingo Mesterheide, Amministratore)

  
.....  
(pp. Bastian Hegel, Documentazione)